

Gateball Q&A

Corresponding to the 2019 Game Rules

The rules made clear!

All your questions answered!

Foreword

This guide is a supplement to the 2019 Official Gateball Rules. Presented in a question and answer format, it covers situations that could occur during a game but cannot be fully covered by the Game Rules.

Using illustrations, explanations and references, this supplement will enable all Gateball fans to easily understand all aspects of the rules.

We hope that this supplement will assist in the correct interpretation and application of the Game Rules, ultimately contributing to the positive and healthy development of Gateball.

World Gateball Union

Contents

Article 1	Ground	Clause 1 Court	6
		Clause 2 Free Zone	8
Article 2	Equipment	Clause 1 Stick	10
		Clause 2 Ball	13
Article 3	Team	Clause 1 Team Structure	15
Article 4	Manager and Players	Clause 3 Clothing	16
Article 5	Preparing for the Game	Clause 2 Deciding Who Goes First	21
		Clause 3 Confirmations and Inspections Before Start of the Game	23
Article 6	How to Play the Game	Clause 3 Start of the Game	25
		Clause 6 Substitution of Players	26
		Clause 7 Absence of Players	30
Article 8	Forfeit	Clause 1 Abandonment	31
		Clause 2 Non-eligible Participation	32
Article 9	Play and Rights as a Stroker	Clause 1 Play and Rights as a Stroker	34

	Clause 2 Time Over	36
	Clause 3 Confirmation by the Stroker	38
<hr/>		
Article 10 Effective Plays and Ineffective Plays		
	Clause 2 Ineffective Plays	42
<hr/>		
Article 11 Movement of the Ball		
	Clause 1 Valid Moves	45
	Clause 2 Invalid Moves	49
<hr/>		
Article 12 Stroking	Clause 1 Stroking	58
	Clause 2 Start Stroking	60
	Clause 3 Gaining the Right for Continuous Stroke	72
	Clause 4 Stroking Foul	78
<hr/>		
Article 13 Passing the Gate ("Gate Tsuka")		
	Clause 1 Successful Pass Through a Gate	90
<hr/>		
Article 14 Finishing ("Agari")		
	Clause 1 A Successful Finish ("Agari")	102
<hr/>		
Article 15 Touch	Clause 1 A Successful Touch	107
	Clause 2 Gaining the Right to Spark	110
	Clause 4 Touching the Same Ball Twice	113
<hr/>		
Article 16 Spark	Clause 1 Spark	115
	Clause 2 Stroker's Actions on Sparking	127
	Clause 3 Completions of Sparking	138
	Clause 4 Sparking Foul	139
<hr/>		

Article 17	In-ball and Out-ball	
	Clause 1	In-ball 162
	Clause 2	Out-ball 163
	Clause 4	Out-ball Stroking Foul 165
<hr/>		
Article 18	Ball Touch Foul	
	Clause 1	Ball Touch Foul 166
<hr/>		
Article 19	Play Interference	
	Clause 1	Play Interference 174
<hr/>		
Article 20	Referee Time	
	Clause 1	Referee Time 180
<hr/>		
Article 21	Exchange of Equipment	
	Clause 1	Exchanging the Stick 183
<hr/>		
Article 22	Interruption of the Game	
	Clause 1	Interruption of the Game 184
<hr/>		
Article 23	Referees	Clause 4 Duties of the Chief Referee
		and Assistant Referee 186
		Clause 6 Duties of the Recorder 187
		Clause 7 Duties of the Linesman 187
<hr/>		
Others	(1)Refereeing Errors	189
	(2)Others	194
<hr/>		

***This book provides explanations that correspond to the 2019 Official Gateball Rules (hereafter referred to as the " Game Rules").**

***Certain clauses of the Game Rules are not referred to in the Q&A book.**

Article **1**

Ground

Clause **1**

Court

Q
1

The line is of a certain width. Where is the boundary between the inside and the outside of the court?

A

The boundary between the inside and the outside of the court is the outside edge of the outside line.

Explanation

The width, color, and the spacing between the inside line and the outside line are determined by agreement for each match or tournament.

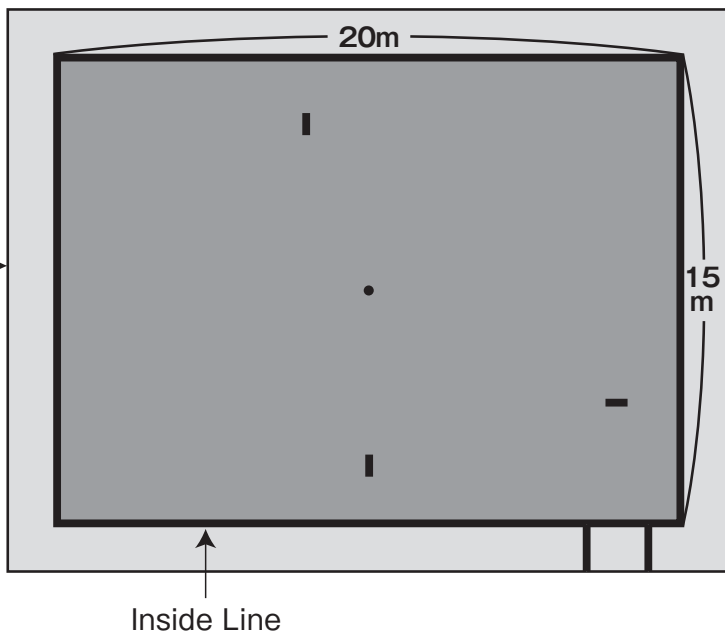
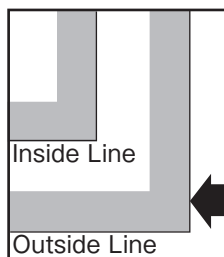

Q
2

How should the referee determine whether a stroker's action occurs within or outside the court?

A

The referee determines whether a stroker's action occurs inside or outside the court by confirming whether the stroker is inside the court, and whether the ball related to the stroker's action is on the field.

Explanation

For example, even if the stroker is outside the court, if the stroker's stick comes into contact with an in-ball or an out-ball on the field, this represents the end of the stroke or a stroking foul.

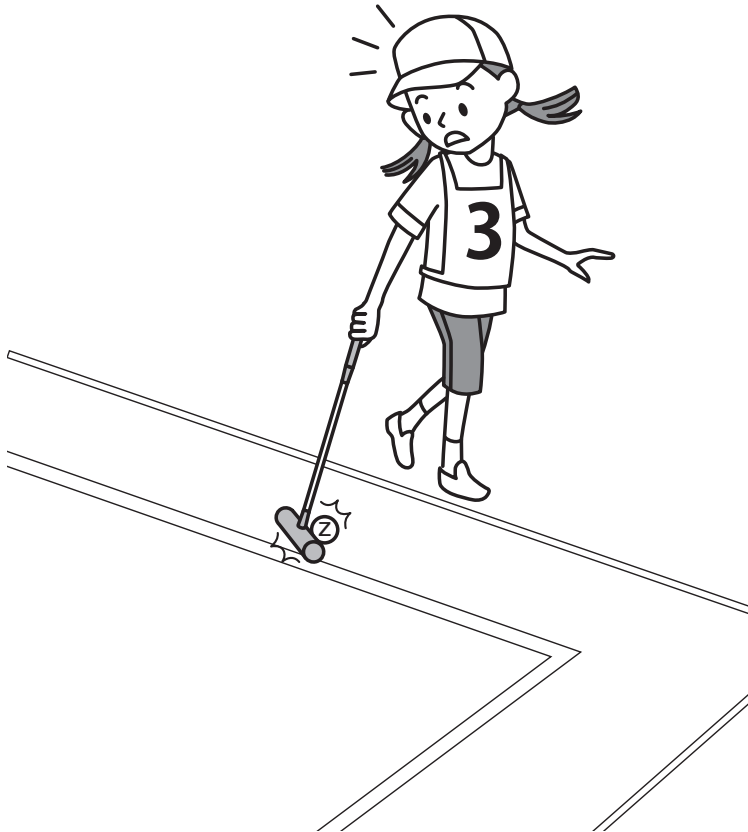

Q
3

Where should the manager or captain be during the game?

**A**

1. Although the manager is normally in the waiting area set up inside the free zone, the manager can enter and move within the free zone during the game as the person responsible for that team.
2. The players in the team that includes the captain can move within the free zone during the game.

Explanation

1. The manager can also issue directions related to, for example, strategy.
2. A player whose turn is about to come up should wait near his/her own ball inside the free zone.
3. The extent of the free zone and where the waiting area is to be set up inside the free zone are determined by agreement at that match or tournament.

Reference

**Article 1, Clause 2, Free Zone 1
(1) of the Game Rules:**

"During a game, only the players, managers, referees and persons invited into the zone shall be allowed to enter."

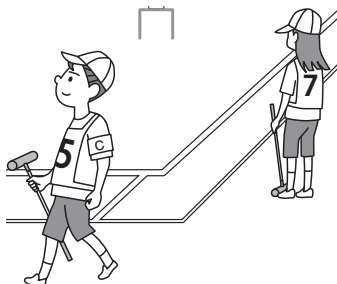

Q 4

How should the waiting area be set up?

A

1. The waiting area is set up in two sections inside the free zone.
2. Seats (chairs or benches) are set up inside the waiting area for the manager and the players.

Explanation

1. Although the setup of the waiting area may differ depending on the court setup, the waiting area should be set up in a way that doesn't hinder the play.
2. The way the score board is set up is determined by agreement for that match or tournament.

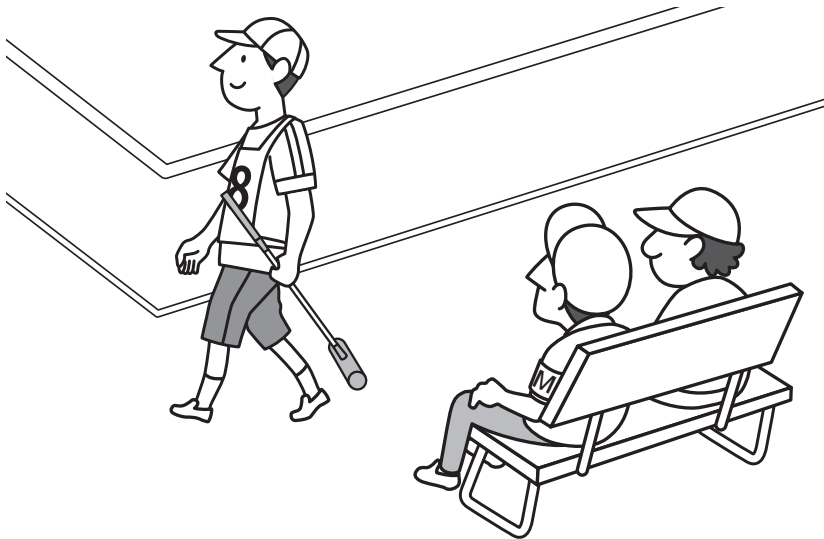

Reference

Article 1, Clause 2, Free Zone 2 of the Game Rules:

"A waiting area shall be set inside the free zone.

- (1) The waiting area shall have seats (benches, chairs, etc.) for the manager and players."

Q
5

Can a stick with an oval or half-moon-shaped face be used?

A

A stick with an oval or half-moon-shaped face can be used, as long as the diameter of the face is 3.5 to 5 cm.

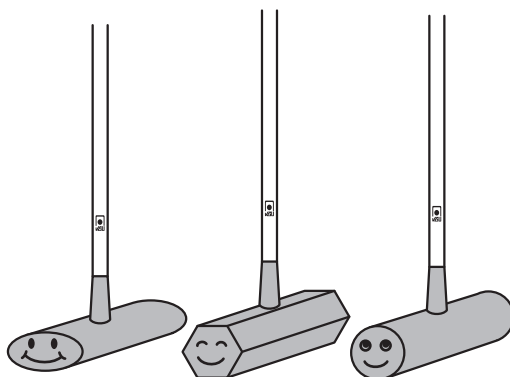
**Explanation**

1. The same applies to a stick with a polygonal-shaped face.
2. As the safety of sticks that have been used for a number of years may be compromised due to metal fatigue etc., check the safety of your stick each time you use it, and if necessary, replace the stick.

Reference**Article 2, Clause 1, Stick 1 (1) (i) of the Game Rules:**

"The face shall be a minimum 3.5 cm, and a maximum 5 cm, in diameter."

Q
6

There is a rule regarding the size of the stick face and the side face, but is there a rule about the weight of the stick?

A

There is no weight limit.

Explanation

The stick should be chosen based on safety considerations, and the size and skills of the player.

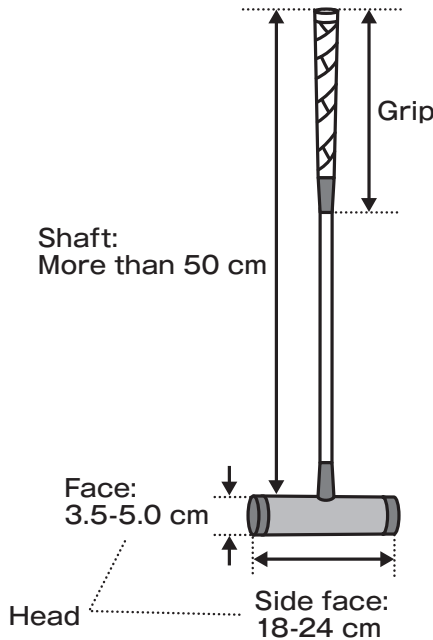

Reference

Article 2, Clause 1, Stick 1 (1) (i) of the Game Rules:

(Refer to the same rule outlined in Q5.)

Article 2, Clause 1, Stick 1 (1) (ii) of the Game Rules:

"The side face shall be 18 cm to 24 cm in length."

Article 2, Clause 1, Stick 1 (2) (i) of the Game Rules:

"The shaft shall be 50 cm or more in length, including the grip."

Q 7

Can tape be wound around the head of the stick, or a rubber cover placed on the face?

A

Tape can't be wound around the head of the stick, nor can it be used in a match with a cover placed on the face.

Explanation

1. Winding tape around a stick, or placing a cover on the stick face, is regarded as a modification to the stick, and so that stick can't be used in a game. However, a tape or a cover can be used to protect the stick when it is being carried outside a game.
2. Winding tape around the stick's grip is not regarded as a modification, and so that stick can be used in a game.

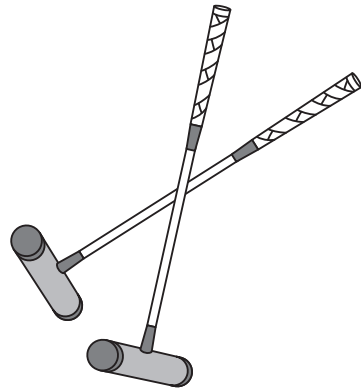
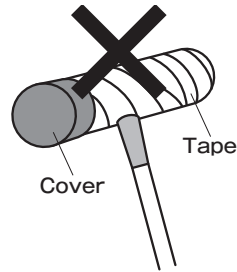

Q
8

There is a rule about the size of the ball, but is there a rule about its weight?

A

Each ball must be 230 g in weight ± 10 g.

Explanation

The weight of each ball must be between 220 g and 240 g.

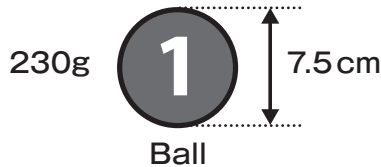
**Reference****Article 2, Clause 2, Ball 1 of the Game Rules:**

"The ball used shall be of an even spherical shape with a diameter of 7.5 cm (± 0.7 mm) and a weight of 230 g (± 10 g), made of synthetic resin. There shall be a total of ten balls: five red balls and five white balls."

Q
9

The ball number is supposed to be visibly marked in at least two locations on the ball. Can a ball that is only marked in two locations be used?

A

A ball that is only marked in two locations can be used.

Explanation

"Marked in at least two locations" also applies to balls in which the number is marked in two locations. It does not mean that the ball has to be marked in three locations.

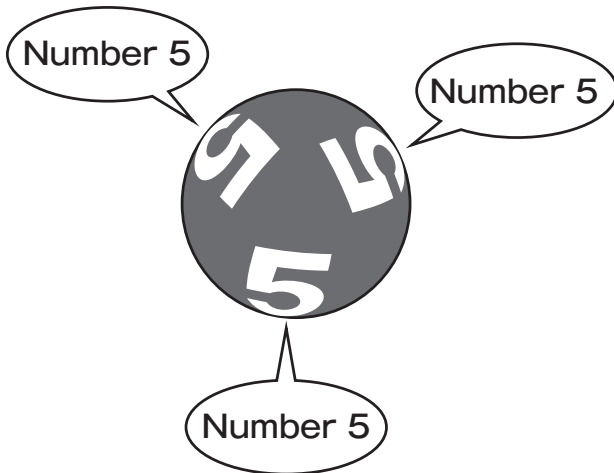
**Reference****Article 2, Clause 2, Ball 1 (3) of the Game Rules:**

"The ball number shall be 5cm in height in principle, and be visibly marked in at least two locations on the ball."

Q
10

Although the number of players in a team is prescribed, are there any rules regarding age or other matters?

A

The Game Rules only prescribe the number of players in a team.

Explanation

1. Rules regarding age or gender may apply depending on the match.
2. Before participating in a match, players should make a note of the implementation conditions of that match.

Q
11

Can a team exist without a manager?

A

A team can exist without a manager. However, please be aware that some matches require a manager as part of the implementation conditions of that match.

Explanation

1. A manager heads the team and is responsible for the actions and comments of that team. The manager also designates the captain and indicates the substitution or absence of a player. The manager can also question the decision of a referee, only at the time that the decision is made.
2. A team should have a manager who is responsible for the team.

Q
12

To what degree should a team's clothing match for it to be accepted as a uniform?

A

The following should be confirmed in order to determine whether a team's clothing matches or not.

- (1) The color, design and shape of the clothing should match, but the following are excluded.
 - 1) Differences in sleeve length (e.g. a long sleeved shirt and short sleeved shirt)
 - 2) Differences in the length of the clothing (e.g. long pants and short pants)
 - 3) Slight differences in color due to fading
 - 4) Differences in clothing worn under the uniform
 - 5) Differences in the name entered in the same location on the uniform, or whether a name is entered or not
 - 6) Differences in color of the buttons on a shirt, or differences in the stitching on the buttons of a shirt
 - 7) Differences between men's trousers and women's skirts, as long as both men and women are wearing the same color
- (2) Cold weather clothing should be matching in color, design and shape.
 - 1) Cold weather clothing should either be worn by all players or none at all.
 - 2) Players should be mindful that cold weather clothing should be worn under the uniform.
- (3) Wet weather clothing should be matching in

color.

1) Wet weather clothing should either be worn by all players or none at all.

(4) Hats should be matching in color, design and shape.

1) Hats should either be worn by all players or none at all.

2) A slight difference in design between hats worn by men and women is permitted as long as the color is the same.

3) Differences in the type of hat, such as men wearing matching caps and women wearing matching hats are permitted, as long as the headwear is in the same color.

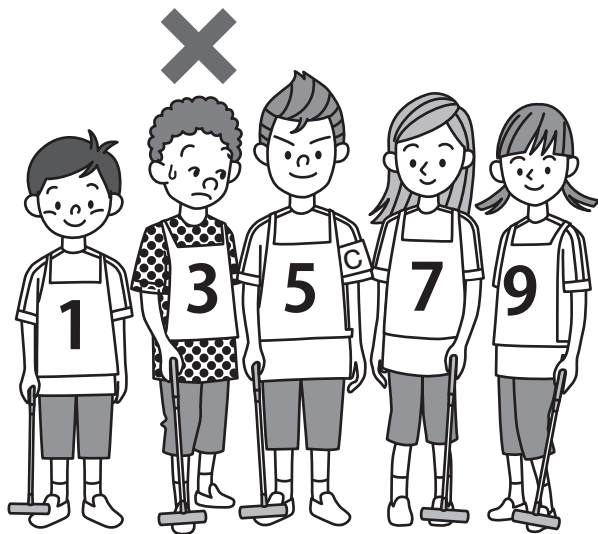

Explanation

1. The clothing and identification worn by team members should be identical, other than the size, and the playing order that is indicated on the identification.
2. Even when cold weather clothing or wet weather clothing is worn, ensure that the identification is worn on the outside so that it is clearly visible.

3. Although uniforms do not include belts, shoes, socks and gloves, it is preferred that these are also matching.
4. As uniforms are checked by the referee before the start of the game, ensure that each member of the team is wearing matching uniforms for the inspection.
5. If a game is played in clothing that hasn't passed the uniform inspection before the start of the game, this will be seen as non-eligible participation and the game forfeited, with the other team winning.

Reference

Article 4, Clause 3, Clothing 4 of the Game Rules:

"All players on the same team must wear the same uniform."

Article 8, Clause 2, Non-eligible Participation 1(2) of the Game Rules:

"If a player plays with equipment and/or a uniform that does not comply with the requirements of the inspection held before the start of the game."

Q
13

What is important in a uniform?

A

The following are important:

- (1) There should be a focus on athletic properties, so that the uniform has sport wear functionality.
- (2) As Gateball is a spectator sport, players should make an effort to wear a uniform with a sense of fashion.

Explanation

As a rule, players are free to wear what they like within reason, but please ensure that the clothing is suitable for an athlete, while clothing that is offensive to public decency should not be worn.

Q 14

Can the identification worn by the manager or captain be any size, as long as it is displayed on the prescribed position, and can the identification worn by the manager, captain or referee be an embroidered patch?

A

1. The identification worn by the manager or captain should be large enough to be recognizable and should be worn in the prescribed position (both the manager and the captain's identification to be worn on the upper arm).
2. Although there is no clear rule regarding the shape of the identification worn by the manager or captain, an armband is preferable as the identification should be visible and easily identified.
3. The identification worn by referees is an embroidered patch of the official referee mark that corresponds to that referee's qualification type. However, the Chief Referee, Assistant Referee, Recorder and Linesman wear an armband as identification.

Explanation

The height of each letter of the identification worn by the manager or captain should be at least 2 cm high.

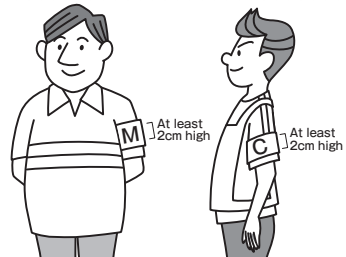

Reference

Article 4, Clause 3, Clothing 2 of the Game Rules:

"The manager must wear an identification on the upper arm noting that he/she is the manager."

Article 4, Clause 3, Clothing 3 of the Game Rules:

"The captain must wear an identification on the upper arm noting that he/she is the captain."

Q

15

Does the manager also have to wear the same uniform as the rest of the team members?

A

The manager does not have to wear the same uniform.

Explanation

1. The five players and the (maximum) three substitutes must wear matching uniforms. The manager, however, does not have to wear the same uniform.
2. The manager must identify himself by wearing a manager's identification mark on the upper arm.

Reference

Article 4, Clause 3, Clothing 2 of the Game Rules:

(Refer to the same rule outlined in Q14)

Q

16

After the players' equipment and clothing is inspected before the start of the game, the weather suddenly deteriorates during the game and it starts to rain. Is the game forfeited if the players then wear wet weather clothing that doesn't match?

A

Yes, the game is forfeited.

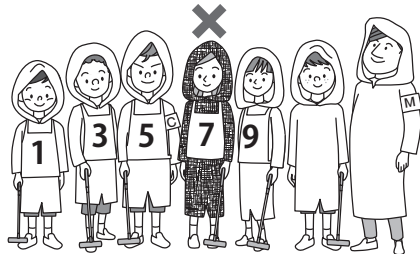

Explanation

Rain weather clothing, which can even be transparent, which has passed the clothing inspection before the start of the game should be worn by all players or none at all.

Q
17

What is the coin toss that is carried out to decide who goes first? Can "stone, paper, scissors" be used?

A

1. The coin toss involves the Chief Referee designating which side of the coin represents each team, and the result of that coin toss determines which team chooses to lead or to follow, and which team chooses the waiting area.
2. As a rule, a coin toss is used to decide which team chooses to lead or follow.

Explanation

1. The Chief Referee carries out the coin toss, as follows, to decide the leading team and the following team.
 - (1) The captain of each team confirms whether the (patterned) surface of the coin represents heads or tails.
 - (2) The Chief Referee then designates which team is heads and which team is tails, notifying this to the captains of both teams.
 - (3) The Chief Referee carries out the coin toss.
 - (4) After confirming whether the side of the coin facing up is heads or tails, the team which won the right to choose whether to lead or to follow is announced.
 - (5) The captain of the team which, as a result of the toss, won the right to choose whether to lead or to follow is then asked to choose whether his/her team is going to lead or follow.
 - (6) The captain of the team which, as a result of the toss, didn't win the right to choose whether to lead or to follow then selects the waiting area.
2. Depending on the match, "stone, paper scissors" is used to decide

which team can choose to lead or follow, or the order of the teams is decided in advance. The decision over which team leads or follows should therefore be made in accordance with the implementation conditions for each match.

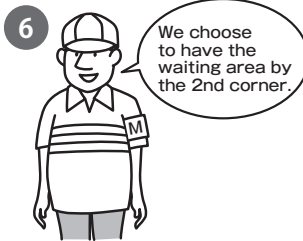
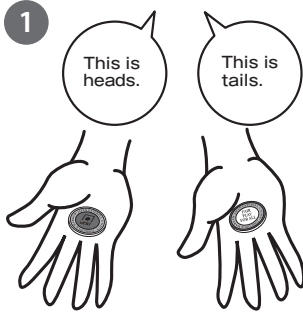

Reference

Article 5, Clause 2, Deciding Who Goes First 1 of the Game Rules:

"After the playing order sheets are submitted by the captains of the respective teams, the referee conducts a coin toss."

Q
18

Where should the captain be positioned when the players line up at the start of the game?

A

Regardless of the stroking order, the captain should be positioned on the referee side (at the head) of the row of players of that team.

Explanation

The captain of the leading team stands on the referee side (at the head of the row of players) of the first stroker, and the captain of the following team stands on the referee side (at the head of the row of players) of the second stroker.

*A captain who is also a substitute player doesn't wear a playing order number, and instead stands on the referee side (at the head of the row of players).



Q 19

The referee inspects the players' equipment before the start of the game. Does any spare equipment also have to be inspected?

A

All sticks to be used in the game must be inspected by the referee before the start of the game.

Explanation

1. Equipment that has not been inspected may not be used in the game.
2. If a stick breaks during a game and the player does not have a spare stick that has been inspected, that player should borrow an inspected stick from another player and then continue playing.



Q
20

What should the referee do when there is a starting player who is not in the line of players at the start of the game?

A

The referee cautions the player to line up with the other players at the start of the game. If, despite being cautioned, the same player does not line up with the other players in his/her team, the Chief Referee may decide that this represents play interference.

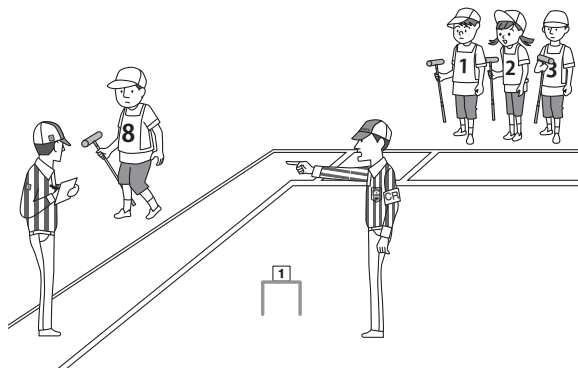
**Reference****Article 6, Clause 3, Start of the Game 2 of the Game Rules:**

"At the beginning of the game, the starting players will line up in the free zone outside the fourth line, in order, from the first player to the tenth player."

Article 19, Clause 1, Play Interference 1 (1) of the Game Rules:

"When a manager or player does not comply with the essential rules governing the manager and player as prescribed in Article 4, Clause 4, and, even though the referee gives warnings, a member of the same team does not follow the instructions of the referee."

Q
21

Can the playing order be changed once the game has started?

A

The playing order may not be changed once the order sheet has been submitted.

Q
22

What is the procedure to receive approval for a player substitution?

A

A player substitution is approved in accordance with the following procedure:

(1) If the substitution is indicated before the player who is being substituted is called to stroke.

1) The manager (or captain) indicates the substitution to the Recorder.

2) The Recorder confirms the substitution, and at that point enters, into the column on substitute players in the record sheet, as "Substitution/(playing order number) - (number of substitutions for that playing order)".

3) The Recorder conveys, to the Chief Referee, "Substitution of Player Number XX)" immediately after the Chief Referee calls on the player who is being substituted, to stroke.

4) The Chief Referee approves and announces the substitution, and the



Recorder enters, into the score column in the record sheet, a partition line on the left hand side of the score column which hasn't been ticked.

- (2) If the substitution is indicated after the player who is being substituted is called to stroke:
 - 1) The manager (or captain) indicates the substitution to the Recorder.
 - 2) The Recorder confirms the substitution, and at that point enters, into the column on substitute players in the record sheet, "Substitution/(playing order number) - (number of substitutions for that playing order)".
 - 3) The Recorder conveys, to the Chief Referee, "Substitution of Player Number XX".
 - 4) The Chief Referee approves and announces the substitution, and the Recorder enters, into the score column in the record sheet, a partition line on the left hand side of the score column which hasn't been ticked.

Q
23

What does the referee do when someone plays without the substitution being indicated to the Recorder?

A

1. If this is made apparent before the next player's stroke or foul play, this represents ineffective play, and that player is ordered off the court, and the ball that moved is returned to the position it was in before it moved.
2. If the next player either strokes or carries out a foul play, the game continues.
 - (1) When it is found that someone has played without the substitution being indicated to the Recorder, the referee first notifies the team that the player substitution must be indicated. The manager then notifies the Recorder of the

substitution. After the player is called to stroke, the Recorder advises to the Chief Referee of the substitution. The Chief Referee then approves and announces the substitution.

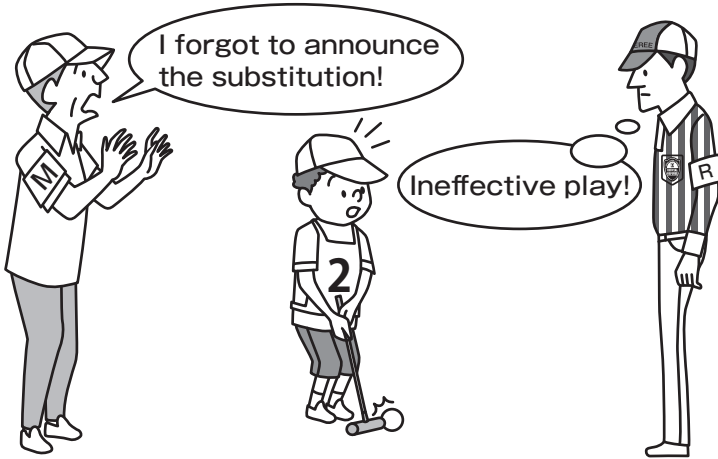

Reference

Article 6, Clause 6, Substitution of Players 1 (1) (iii) of the Game Rules:

"If the fact that a substitute player has been playing without indicating the substitution was found out before the stroke or foul play of the next stroker has been made, the play shall become ineffective."

Q
24

If a player being substituted is called to stroke, what does the referee do if the substitute player is not wearing a playing order number?

A

The Chief Referee must not approve the substitution. The referee calls on the stroker who was to be substituted to play, and the referee counts 10 seconds.

Explanation

1. As the time required for a player to wear a player order number is not included in referee time, the referee will count 10 seconds.
2. As the substitution has not been approved, the 10 second count by the referee is carried out on the player who was to be substituted.
3. The 10 second count begins when the player is called to stroke.

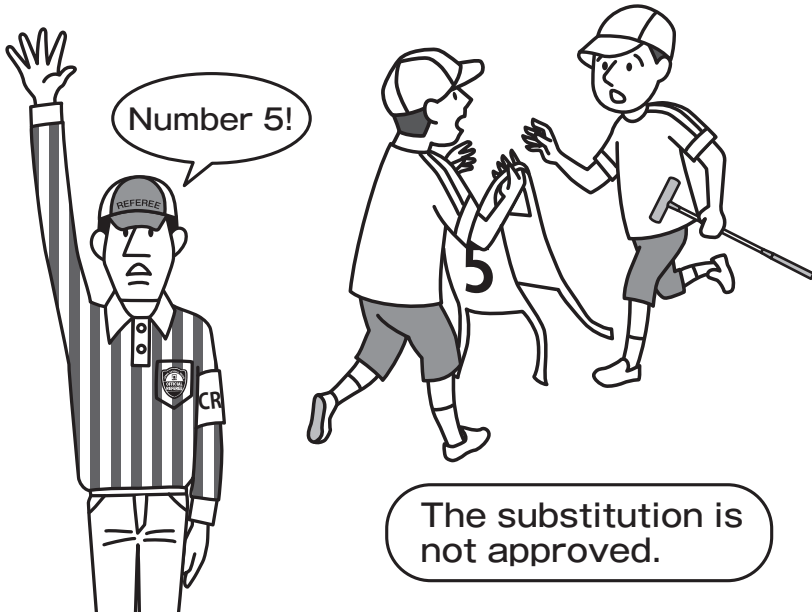
**Reference****Article 6, Clause 6, Substitution of Players 1 (3) (ii) of the Game Rules:**

"If the substitute player is not wearing the appropriate playing order number when the player who will be substituted is called to stroke."

Article **6****How to Play the Game**Clause **7****Absence of Players****Q**
25

What should the referee do if a player is absent, but the manager (or captain) hasn't reported this?

A

If the manager or captain does not report an absent player, the Chief Referee announces the stroke after carrying out the 10 second count, which means that Time Over is applied.

Explanation

Even after a player becomes absent, movements of that player's ball are still valid and points can be scored. Absentees must therefore be reported in order to reduce any wasted time.

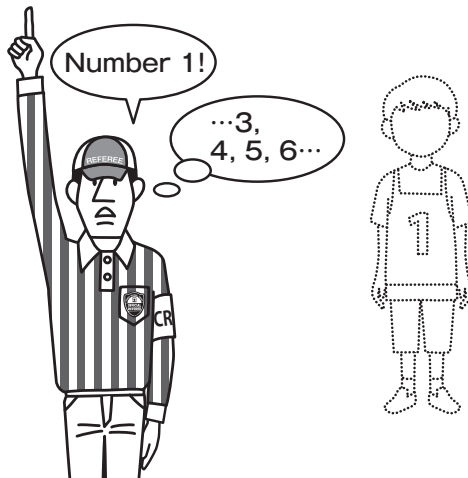
**Reference**

Article 6, Clause 7, Absence of Players 1 (1) of the Game Rules:

"This must be immediately reported to the referee by the manager."

Q
26

A player becomes absent just before the start of the game. If there is no substitute player, can the manager become a player in that game?

A

The manager's role is a full-time role, and therefore he/she may not be a player as well.

Explanation

This would be seen as abandoning the game, and the other team would then win by forfeit.

Reference

Article 8, Clause 1, Abandonment 1 (2) of the Game Rules:
"A team has less than five players at the start of the game."

Q
27

What does the referee do when a team announces, during the game, that it is abandoning the game?

A

As the game is forfeited at that point, the Chief Referee announces "Game Set", and the other team wins the game.

Reference

Article 8, Clause 1, Abandonment 1 (1) of the Game Rules:
"A team announces their intentions to abandon the game."

Q
28

A member of a team that is registered to participate in a game is therefore qualified to play. However, if confirmations and inspections are not carried out on that player before the start of the game, does this mean that the player cannot play in that game?

A

Even though the member is registered, if a player hasn't been confirmed and inspected before the start of the game, then that player is not qualified to participate in the game.

**Explanation**

1. The referee carries out a confirmation of the players participating in a game by confirming their playing order sheet and playing order and inspecting their equipment and clothing.
2. If a player other than the one entered into the order sheet plays, this represents non-eligible participation, the game is forfeited and the other team wins.

Reference

Article 8, Clause 2, Non-eligible Participation 1 (1) of the Game Rules:

"If anyone other than those listed in the playing order sheet plays in the game."

Q
29

What does the referee do when it becomes apparent that anyone other than those listed in the playing order sheet has played in the game?

A

As the game is forfeited at that point, the Chief Referee announces "Game Set", and the other team wins the game.

Game Set

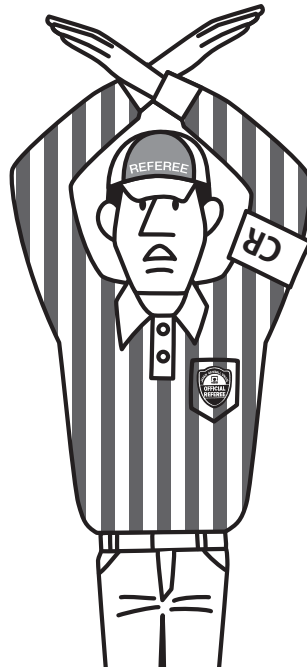

Reference

Article 8, Clause 2, Non-eligible Participation 1 (1) of the Game Rules:

(Refer to the same rule outlined in Q28)

Article **9****Play and Rights as a Stroker**Clause **1****Play and Rights as a Stroker****Q**
30

If a stroker who has entered the court then exits the court, does that stroker lose the right to stroke at that point?

A

Even if a stroker leaves the court, the stroker does not lose the right to stroke as a result of leaving the court.



Q 31

I sometimes see a manager or captain issuing instructions to the stroker from the outer field. Can someone other than the stroker enter the court as long as he/she does not enter the inner field?

A

No one other than a stroker can enter the court.

Explanation

1. The referee will order anyone other than the stroker who has entered the court (within the outside line) to leave the court.
2. If a member of that team ignores the referee despite being cautioned, the Chief Referee shall apply the play interference rule.

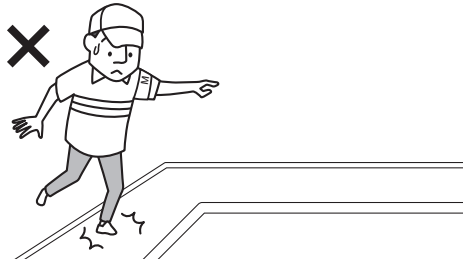

Reference

Article 1, Clause 1, Court 2 (1) of the Game Rules:

"The field refers to the surface inside the court. The field is divided into the inner field and the outer field."

Article 9, Clause 1, Play and Rights as a Stroker 1 (1) of the Game Rules:

"The stroker can enter the court to play."

Article 9, Clause 1, Play and Rights as a Stroker 4 of the Game Rules:

"When the rights as a stroker end, the stroker shall promptly exit the court."

Article 19, Clause 1, Play Interference 1 (1) of the Game Rules:

"When a manager or player does not comply with the essential rules governing the manager and player as prescribed in Article 4, Clause 4, and, even though the referee gives warnings, a member of the same team does not follow the instructions of the referee."

Article **9****Play and Rights as a Stroker**Clause **2****Time Over****Q**
32

During the game, should the referee use apparatus or equipment such as a time score or stopwatch to count the 10 seconds?

A

The referee should count the 10 seconds without relying on any apparatus or equipment such as a time score or stopwatch.

Explanation

1. The 10 seconds counted by the referee shall be the final measured time.
2. Using apparatus or equipment can result in a delay in starting the count of 10 seconds, or can result in the referee overly focusing on the apparatus or equipment, and not making an accurate decision on a stroker's move or ball movement.
3. As the 10 seconds counted by the referee is the final measured time, the referee should ensure the 10 seconds is counted as accurately as possible.
4. The portable watch (stopwatch) used by the referee is used to measure the time when, for example, the game has been interrupted.

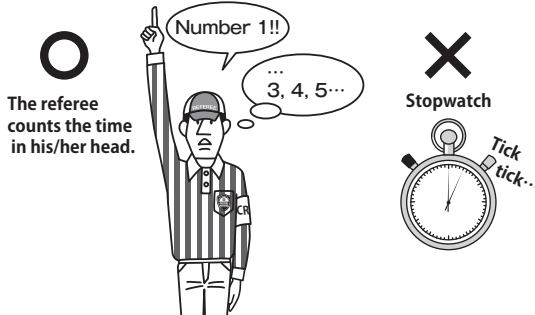

Q

33

After a Touch is achieved with ball A and ball B, the stroker's own ball and the two balls with which the stroker's ball made a Touch are all in contact, and have stopped as in-balls. As ball A is to be sparked next, ball B is temporarily moved. Should the 10 seconds continue to be counted during this move?

A

The 10 second count continues even while the stroker is temporarily moving the ball.

Explanation

1. If the referee determines that the ball temporarily moved by the stroker is hindering the game, then the time to adjust the position of the ball becomes referee time and therefore is excluded from time over. However, the time required by the stroker to temporarily move the ball is not included in referee time, and therefore the 10 second count is continued.
2. When the stroker confirms, with the referee, that the other ball is in contact with his/her ball, the time taken by the referee to respond to this becomes referee time. However, the time required by the stroker to confirm this is not included in referee time, and therefore the 10 second count is continued.

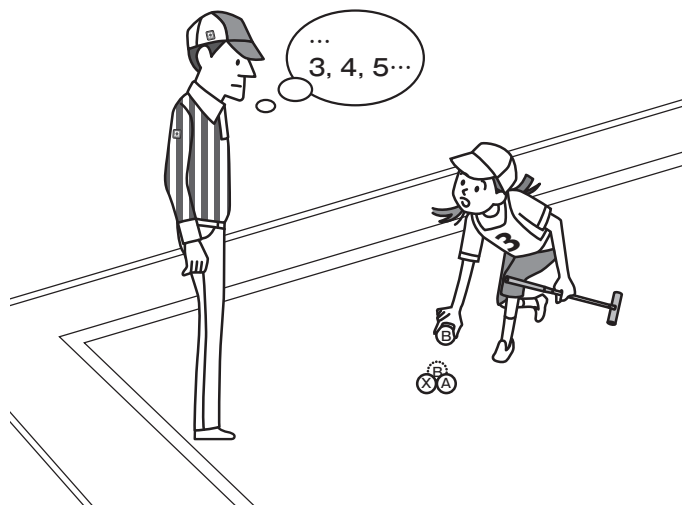

Article **9****Play and Rights as a Stroker**Clause **3****Confirmation by the Stroker****Q**
34

Why is it necessary for a stroker to confirm that the stroker's ball and the touched ball(s), and the touched ball(s) and other ball(s) are in contact?

A

It is necessary to ensure that the referee's decision and the stroker's decision are consistent.

Explanation

1. If the stroker's ball or other ball moves as a result of that player picking up a touched ball, and if the stroker's ball and the touched ball, or the touched ball and another ball are in contact, this represents an invalid move. However, if they are not in contact, then this represents a sparking foul.
2. If the stroker's ball and several touched balls are adjacent to each other, the following applies, depending on the situation:
 - (1) If there are multiple balls in contact with the stroker's ball, the stroker can temporarily move any touched balls other than the one which will be sparked next, then spark the

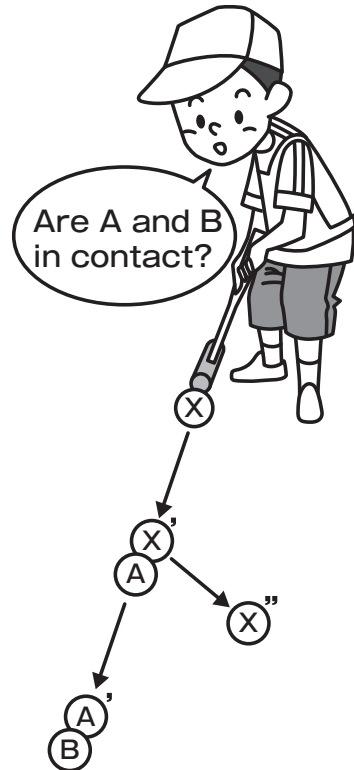

balls, one ball at a time.

- (2) If there is only one ball in contact with the stroker's ball, the ball in contact with the stroker's ball is sparked first. However, if the stroker comes into contact with a touched ball that is not in contact with his/her ball before a successful Spark of the ball in contact with the stroker's ball, then this becomes a sparking foul.

Reference

Article 9, Clause 3, Confirmation by the Stroker 1 (4) (i) of the Game Rules:

"Whether or not there is a contact situation between the stroker's ball and touched other ball(s) after a Touch."

Article 9, Clause 3, Confirmation by the Stroker 1 (4) (ii) of the Game Rules:

"Whether or not there is a contact situation between the touched ball(s) and other ball(s) after a Touch."

Article 11, Clause 2, Invalid Moves 1 (9) (i) of the Game Rules:

"When the stroker's ball stops in contact with another touched ball, and the stroker's ball moves as the result of the stroker picking up the touched ball as part of a stroker's action on sparking."

Article 11, Clause 2, Invalid Moves 1 (9) (ii) of the Game Rules:

"When a touched ball comes into contact with yet another ball and stops, and that other ball moves as the result of the stroker picking up the touched ball as part of a stroker's action on sparking."

Article 16, Clause 4, Sparking Foul 1 (1) of the Game Rules:

"After picking up a touched ball, and before the Spark, the stroker's ball or another ball is directly moved by the touched ball."

Article 16, Clause 4, Sparking Foul 1 (7) of the Game Rules:

"If, after touching several balls and picking up the first touched other ball, the order of the Spark is changed."

Article 16, Clause 4, Sparking Foul 1 (8) of the Game Rules:

"If the stroker comes into contact with several touched other balls simultaneously, other than when the stroker's ball stops in contact with 3 or more touched other balls, and the balls to be sparked after the first touched ball are temporarily moved."

Article 16, Clause 4, Sparking Foul 1 (9) of the Game Rules:

"If the stroker's own ball is in contact with the touched other ball and the stroker comes into contact with yet another touched other ball."

Q

35

Why does the stroker have to confirm a successful pass through a gate?

A

This has to be confirmed in order to ensure that the referee's decision and the stroker's decision are consistent.

Explanation

1. By confirming whether a ball on the gate line moved towards the back side of the gate as a result of a proper play, the stroker can confirm whether the pass through the gate was successful.
2. When the outer edge of the ball is lying on the gate line, the Recorder enters, into the score column in the record sheet, a small circle in the corresponding (top left) section, and draws a horizontal line through that circle when the outer edge of the entered ball moves away from the gate line, in any of the following situations:
 - (1) The in-ball moves from the back side, and the outer edge of the ball stops on the gate line of the next gate through which the ball is to be passed through.

Back side

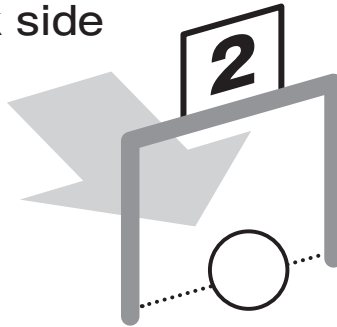

Front side

- (2) When, as the result of stroking an out-ball, the outer edge of the ball stops on the gate line of the next gate through which the ball is to be passed through.

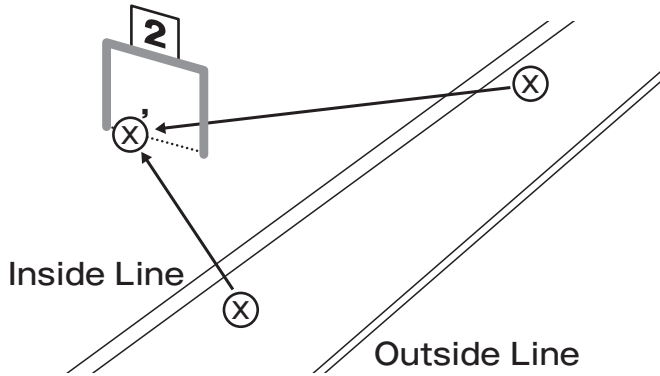

(3) When, as the result of a sparking foul after the ball(s) have been set, the outer edge of the other ball is set on the gate line of the next gate through which it is to be passed through.

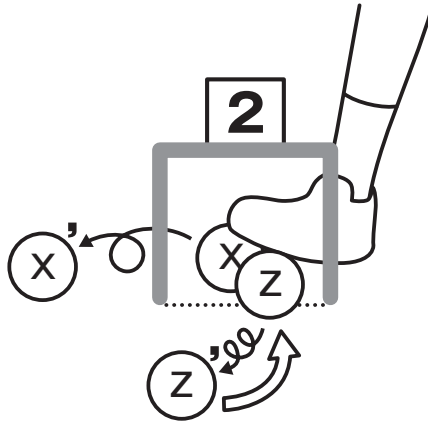

Reference

Article 9, Clause 3, Confirmation by the Stroker 1 (1) (i) of the Game Rules:

"When the outer edge of a stationary ball is on a gate line, whether or not it will make a successful pass through the gate if it moves towards the back side of the gate to completely cross over the gate line."

Article 9, Clause 3, Confirmation by the Stroker 1 (1) (ii) of the Game Rules:

"Whether or not the outer edge of the other ball set for sparking is on the gate line."

Article **10****Effective Plays and Ineffective Plays**Clause **2****Ineffective Plays****Q**
36

If a stroker strokes a ball during referee time, is this a foul?

A

No, it is not a foul.

Explanation

1. Any play during referee time represents an ineffective play. A ball that has moved as a result of a stroke represents an invalid move, and all the balls that have moved are returned to their position before they moved.
2. Any play during referee time prevents the game from continuing as it should, and therefore is discouraged.

**Reference**

Article 10, Clause 2, Ineffective Plays 1 (1) of the Game Rules:
 "Plays made by a stroker during referee time."

Q

37

At a start stroke, the stroker's ball hits another ball that is on the front side of the first gate, makes a successful pass through the first gate, and then stops within the inner field. After this, as the referee is returning the other ball that has made an invalid move to the position before it moved, the stroker strokes his/her ball. Is this a proper play?

A

This is not a proper play, but an ineffective play.

Explanation

1. The player gains the right for continuous stroke, but the time required for the referee to return the other ball to its original position before it moved becomes referee time. Any movement of the ball as the result of a play by a stroker during referee time represents an invalid move.
2. The referee returns any balls that have moved to the positions they were in before they moved and makes the stroker stroke once again.
3. If a ball that hasn't passed through the first gate causes a ball other than the stroker's ball to move and the stroker comes into contact with that moved ball, the play is ineffective because it occurred during referee time.
4. Any play during referee time prevents the game from continuing as it should, and therefore is discouraged.

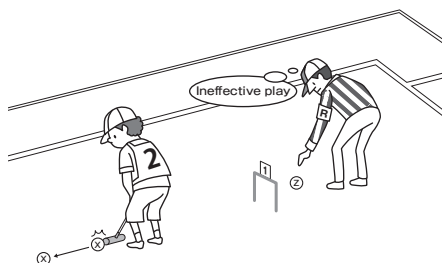

Reference

Article 10, Clause 2, Ineffective Plays 1 (1) of the Game Rules:
(Refer to the same rule outlined in Q36)

Q

38

A foul is announced to a stroker, and that stroker is about to leave the court when his/her foot comes into contact with a ball in the field. Would this affect the next player in that stroker's team?

A

It represents an ineffective play, so it will not affect the next player in that stroker's team.

Explanation

1. The stroker loses his/her right to stroke as soon as the foul is announced.
2. As a move by a player whose right to stroke has ended represents an ineffective play, the ball that has moved represents an invalid move. The ball is therefore replaced by the referee to where it was before the move.
3. Similarly, if a stroker who has achieved a successful finish ("Agari") comes into contact with another ball on the field as he/she is about to leave the court, the ball that has moved represents an invalid move, and that ball is replaced by the referee to where it was before the move.
4. Players whose right to stroke has ended should be mindful not to come into contact with any balls on the court and, as a result, impede the progress of the game.

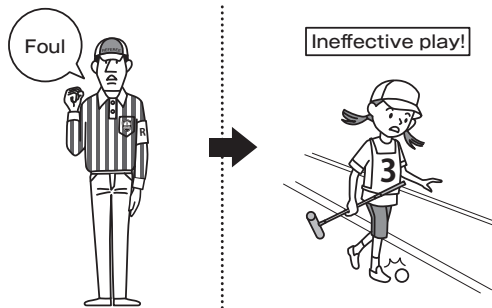

Reference

Article 10, Clause 2, Ineffective Plays 1 (2) of the Game Rules:
 "Actions of a person other than the stroker."

Q
39

A player strokes his/her ball that is in contact with the gate, and ends up stroking the ball and the leg of the gate at the same time. Is this a stroking foul?

A

This is not a foul.

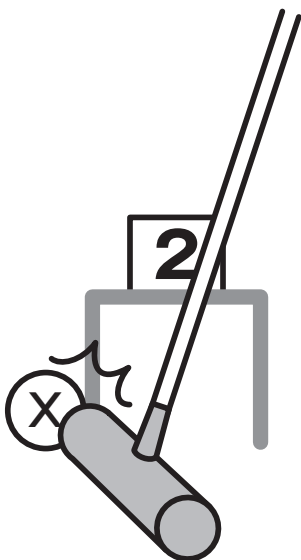
**Explanation**

Stroking, at the same time, one's own ball and the gate that the ball is in contact with represents a valid stroke.

Q 40

A stationary stroker's ball is in contact with the gate. Another ball is in contact with the other leg of the same gate. The stroker then strokes his/her ball, indirectly causing the ball in contact with the gate to move. Is it an invalid move?

A

Both of the movement of the stroker's ball and the other ball is valid.

Explanation

1. As stroking one's ball is a proper play, the stroker's ball remains in the position where it stopped after being stroked.
2. As the movement of the other ball in contact with the gate is also a valid move, that ball remains in the position where it stopped.

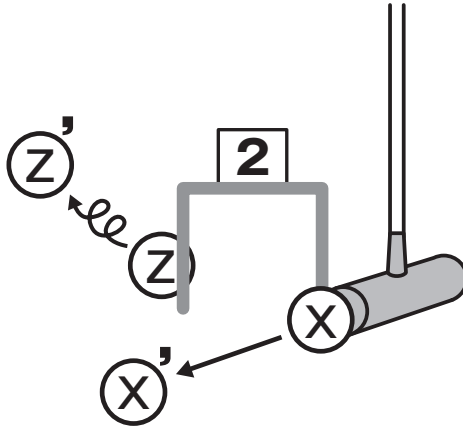

Reference

Article 11, Clause 1, Valid Moves 1 of the Game Rules:

"Aside from invalid moves, all movements of balls as a result of a proper play by a stroker shall be valid."

Q

41

After a successful Touch with ball A, the stroker's ball stops in contact with the gate, while ball B is in contact with the other leg of the same gate. The stroker picks up ball A and sparks, and the outer edge of ball A ends up 10cm or more away from the outer edge of the stroker's ball. However, the impact of the Spark causes ball B, in contact with the gate, to indirectly move. Does indirectly moving ball B represent a sparking foul?

A

It represents a proper spark, not a foul.

Explanation

1. Because the move was valid, ball B remains in the position where it stopped.
2. The stroker can then stroke his/her own ball one more time.

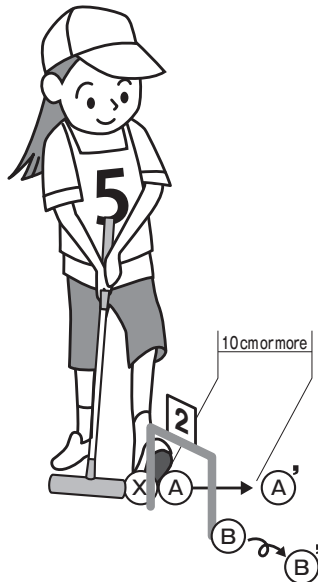

Q
42

When a stroker strokes his/her ball to carry out a Pass Touch (Touch Pass) with a ball that is in contact with the gate, the stroker's ball hits the gate and makes a successful pass, then hits the ball that is in contact with the gate, causing this ball to move. Does this represent a successful Pass Touch? Is the movement of the other ball valid?

A

It represents a successful Pass Touch.

Explanation

The movement of the other ball is valid. The stroker can stroke his/her own ball twice after making a successful Spark.

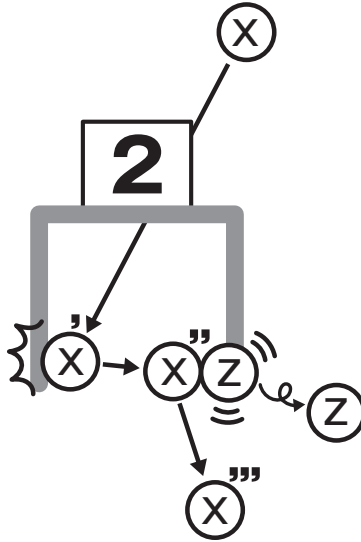

Reference

Article 12, Clause 3, Gaining the Right for Continuous Stroke 1 (3) of the Game Rules:

"When a successful pass through a gate and a successful Touch are made with the same stroke, the stroker can stroke his/her ball two times more after making a successful Spark."

Q 43

When a ball (balls) move(s) as the result of an invalid move, all ball(s) other than those that made a valid move must be returned to their respective positions before the move. What are some examples?

A

A stroker's ball that is also an out-ball is stroked into the court, and the stroked ball hits the second gate. As a result, ball A that was in contact with the leg on the other side of the second gate moves and hits ball B.

- 1) The stroker's ball makes a valid move and therefore remains in the position it stopped in after moving. However, if the stroker's ball stops in the position where ball A or B was in before they moved, ball A or ball B, when returned to their positions, end up in contact with the stroker's ball. This represents an out-ball stroking violation and therefore a foul, and the stroker's ball becomes an out-ball from where it was when the foul was committed.
- 2) As ball A moved as a result of the stroker's ball hitting the gate, this is an invalid move, and the ball is returned to the position it was in before it moved.
- 3) As ball B moved as a result of an invalid move by ball A, ball B is also returned to the position it was in before it moved.

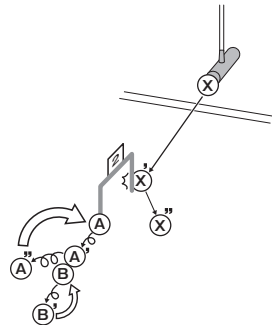

Reference

Article 11, Clause 2, Invalid Moves 2 of the Game Rules:

"When a ball(s) move(s) as the result of an invalid move, that ball(s) shall be returned to its position before the move, except for the ball(s) making the valid move."

Q
44

At a start stroke, the stoker's ball hits the leg of the first gate but then completely crosses over the gate line, resulting in a successful pass through the first gate. At this point, another ball in contact with the leg on the other side of the gate moves. Is the move of this ball valid?

A

The move of the ball is not valid, but invalid.

Explanation

If the stoker's ball stops on the inner field, the stoker gains the right for continuous stroke. Once the referee returns the moved ball to where it was before it moved, the stoker can stroke one more time.

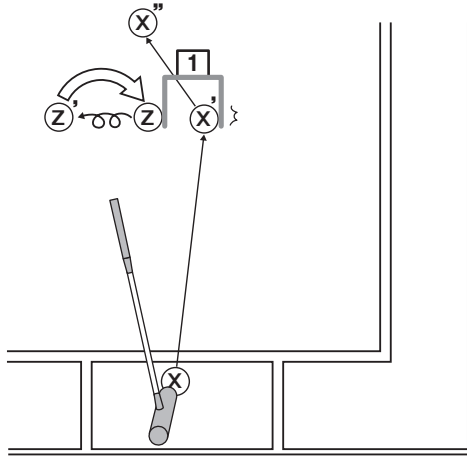

Reference

Article 11, Clause 2, Invalid Moves 1 (3) of the Game Rules:

"The movement of other ball(s) made by the ball which has not yet passed through the first gate."

Q 45

When a ball that has successfully passed through the third gate is in contact with the goal-pole and stops, and the stroker's ball that has successfully passed through the third gate hits the goal-pole, does this represent a successful finish ("Agari") of the other ball?

A

This does not represent a successful finish ("Agari") of the ball.

Explanation

Even if the ball that was in contact with the goal-pole had made a successful pass through the third gate, it is only the stroker's ball that has finished ("Agari"), and so the movement of that other ball represents an invalid move. Therefore, the ball is returned to the position it was in before it moved

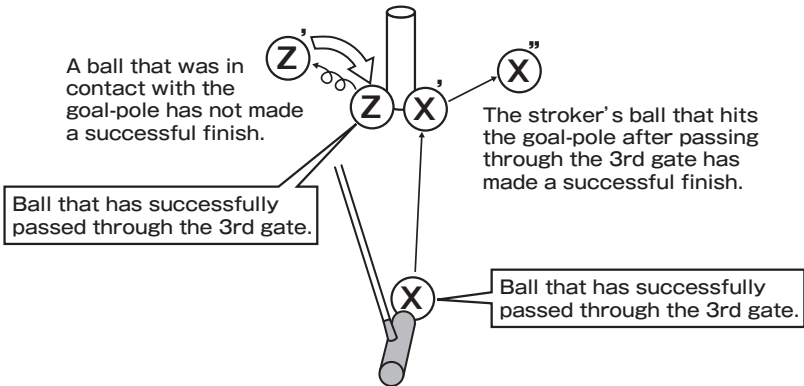

Reference

Article 11, Clause 2, Invalid Moves 1 (6) of the Game Rules:

"Moving a ball that has finished, and other ball(s) moved as a result of this move."

Q 46

When stroking one's ball that is in contact with the gate, the stick face hits only the gate, causing the stroker's ball to move indirectly. Does indirectly moving the ball represent a stroking foul?

A

It is not a foul.

Explanation

1. As the stroker's ball has made an invalid move, after the referee has returned all the balls to their positions they were in before they moved, the stroker strokes his/her ball within the 10 second count.
2. Similarly, when sparking one's own ball that is in contact with the gate, and the stick face hits only the gate causing the set ball to move indirectly, the move of that ball is invalid, and the referee returns all the balls to their positions they were in before they moved.



Reference

Article 11, Clause 2, Invalid Moves 1 (10) (iii) of the Game Rules:

"When a ball in contact with a gate or the goal-pole is moved indirectly as a result of the stick coming in contact with the gate or the goal-pole."

Q
47

A ball comes into contact with the gate and then stops, when the stroker drops his/her stick which then hits that gate. Although the stick didn't hit the ball in contact with the gate, is it still a foul?

A

No, it is not a foul, but an invalid move.

Explanation

1. As the stick dropped by the stroker came into contact with the gate with which the ball is in contact, rather than with the ball itself, it is not a foul.
2. The movement of the ball that was in contact with the gate is invalid and therefore the ball is returned to the position it was in before it moved.

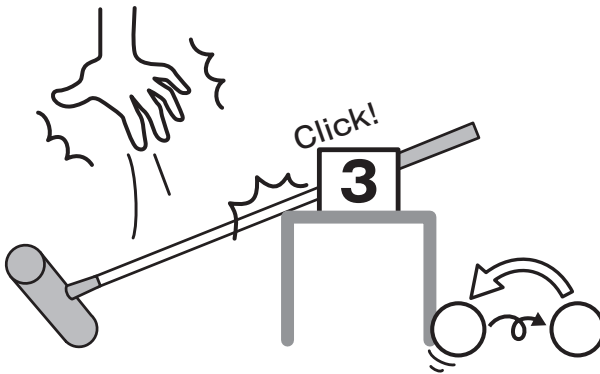

Reference

Article 11, Clause 2, Invalid Moves 1 (10) (iii) of the Game Rules:
(Refer to the same rule outlined in Q46)

Q 48

A stroke was attempted, and the stick hit the grass, causing the stoker's ball to move, although the stick didn't hit that ball. Is this a foul?

A

It is not a foul.

Explanation

As the movement of the stoker's ball is an invalid move, the stoker can stroke his/her ball within 10 seconds after the referee places the stoker's ball in the position it was in before it moved.



Reference

Article 11, Clause 2, Invalid Moves 1 (10) (ii) of the Game Rules:

"When a ball is moved indirectly by hitting soil or grass with the stick."

Q 49

When attempting to reset the balls before a Spark, the stroker's foot comes off the stroker's ball and the stroker picks up the set ball, causing the stroker's ball to move. Is this a sparking foul?

A

It is not a foul.

Explanation

As the movement of the stroker's ball is an invalid move, the stroker can stroke his/her ball within 10 seconds after the referee places the player's ball in the position it was in before it moved.

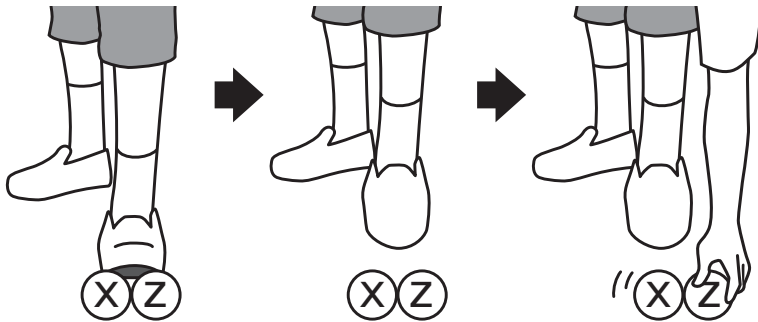

Reference

Article 11, Clause 2, Invalid Moves 1 (9) (vii) of the Game Rules:

"If, when resetting the balls, the stroker's ball is moved as a result of the stroker picking up the set other ball while he/she is not stepping on his/her ball."

Q 50

The stroker's ball touches ball A, causing ball A to move and come into contact with ball B and then stop. In order to spark ball A, the stroker confirms with the Referee that ball A and ball B are in contact, then picks up touched ball A, causing ball B to move. Is this a foul?

A It is not a foul.

Explanation

1. As ball B has moved as a result of the stroker picking up ball A, it is an invalid move, not a foul.
2. The referee places ball B in the position it was in before it moved.

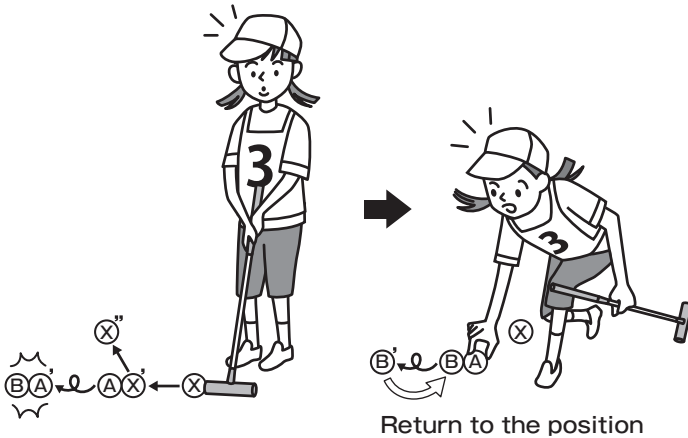

Reference

Article 9, Clause 3, Confirmation by the Stroker 1 (4) (ii) of the Game Rules:

"Whether or not there is a contact situation between the touched ball(s) and other ball(s) after a Touch."

Article 11, Clause 2, Invalid Moves 1 (9) (ii) of the Game Rules:

"When a touched ball comes into contact with yet another ball and stops, and that other ball moves as the result of the stroker picking up the touched ball as part of a stroker's action on sparking."

Q 51

With an invalid move, is it a foul if the stroker returns the ball to the position it was in before it moved?

A It is not a foul.

Explanation

1. As the time taken by the referee to return the ball that has made the invalid move to the position it was in before it moved represents referee time, any act by the stroker during this time represents an ineffective play.
2. A stroker returning a ball that has made an invalid move to the position it was before it moved may prevent the game from continuing as it should, and therefore is discouraged.



Reference

Article 10, Clause 2, Ineffective Plays 1 (1) of the Game Rules:
"Plays made by a stroker during referee time."

Article **12** **Stroking**

Clause **1** **Stroking**

Q 52 A stroker misses when attempting to stroke his/her ball. Does this mean the end of the stroke?

A It is not the end of the stroke.

Explanation

The player should stroke within 10 seconds of the call to stroke being made, or of the stroker gaining the right for continuous stroke.



Q
53

Is it a foul if a stroker strokes his/her ball at a start stroke or out-ball stroke when standing on or straddling the line?

A

It is not a foul.

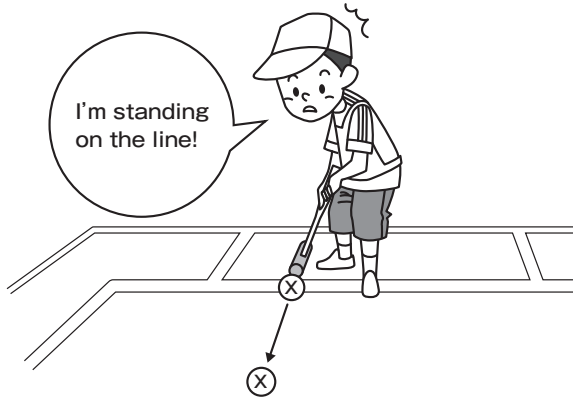

Q
54

If the stroker hits the ground or grass at the same time as stroking his/her ball, is this a stroking foul?

A

It is not a foul, but is a proper stroke.



Article **12** **Stroking**

Clause **2** **Start Stroking**

Q
55

During a start stroke, is it a foul if the stroker's foot comes into contact with the stroker's ball which has been placed in the start area using the hand?

A

It is a ball touch foul.

Explanation

1. The stroker's ball is removed from the field.
2. If the stick face came into contact with the stroker's ball, then this marks the end of the stroke.
3. If any part other than the face of the stick came into contact with the stroker's ball, then this represents a stroking foul.

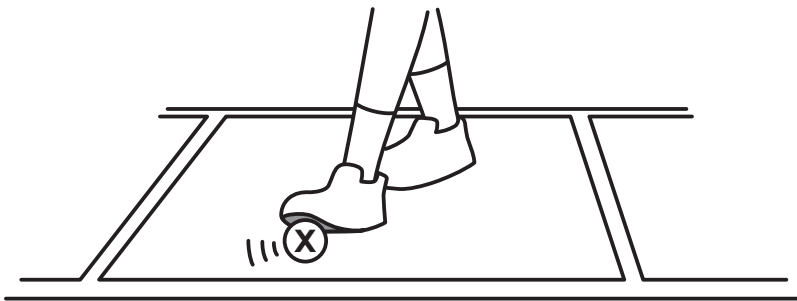

Reference

Article 12, Clause 2, Start Stroking 1 (1) of the Game Rules:

"The stroker can use his/her hand to reposition his/her ball which has been once placed in the start area."

Article 18, Clause 1, Ball Touch Foul 2 (1) of the Game Rules:

"If a stroker comes into contact with a stationary ball."

Q 56

If, during a start stroke, the stroker's ball is placed in the field but outside the start area and stroked, where exactly on the field does this refer to?

A

This refers to stroking the ball that has been placed anywhere in the inner field, or in the outer field that isn't the start area.

Explanation

This represents a stroking foul, and the stroker's ball is removed from the field.

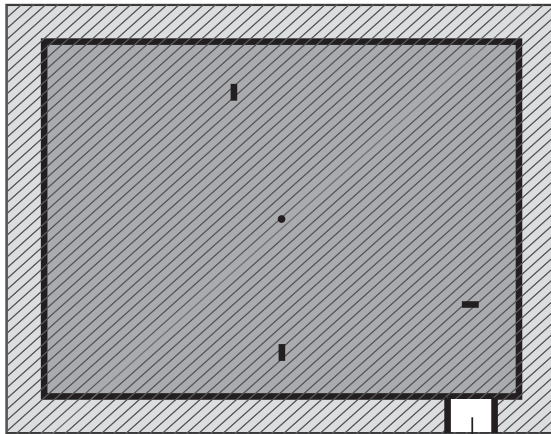

The diagonal lines represent the area outside the start area.

Start area

Reference

Article 12, Clause 2, Starting Stroke 1 of the Game Rules:

"The start stroking refers to the act of a stroker placing his/her own ball which has not made a successful pass through the first gate with his/her hand in the start area and stroking it."

Article 12, Clause 4, Stroking Foul 1 (10) of the Game Rules:

"If, during the start stroking, the stroker's ball is placed in the field but outside the start area."

Q
57

If a stroker's ball in the free zone is moved into the start area by using the stick or foot, is this regarded as the stroker's ball being placed in the start area?

A

This does not represent the stroker's ball being placed in the start area.

Explanation

1. In principle, the hand should be used to place the stroker's ball in the start area.
2. It is not a start stroke if the stick or foot is used to draw the stroker's ball from outside the court into the start area before the ball stroked.
3. It is not a foul if the stroker's ball which has been drawn into the court from outside the court using the stick or foot comes into contact with the foot.
4. It is not appropriate behavior for a stroker to draw a ball in the free zone using the stick or foot. When start stroking, the stroker should check his/her ball and then place it in the start area using the hand.

Reference

Article 12, Clause 2, Starting Stroke 1 of the Game Rules:

(Refer to the same rule outlined in Q56.)

Q
58

During a start stroke, the stroker uses the hand to place his/her ball in the start area before the stroke is called, and when the stroke is called, strokes the ball. Does this represent a successful start stroke?

A

No, this does not represent a successful start stroke.

Explanation

1. As a ball that shouldn't be in the start area in the first place is already in the start area when the stroke is called, as long as the stoker does not reposition his/her ball after the stroke is called, this is not regarded as the stoker's ball being placed in the start area.
2. It is not a start stroke even when the stoker hits his/her ball placed in the start area before the stroke is called.
3. It is not a foul even the foot comes into contact with the stoker's ball that has been placed in the start area before the stroke is called.
4. Similarly, if the stoker's ball or another ball is placed on the field before the stroke is called, as long as the ball isn't repositioned with the hand after the stroke is called, it is not a stroke even if that ball is stroked, while it is not a foul even if the foot comes into contact with the stoker's ball.
5. It is not appropriate behavior for a stoker to place his/her ball on the field before the stroke is called. When start stroking, the stoker's ball should be placed in the start area after the stroke is called.

An appropriate start stroke

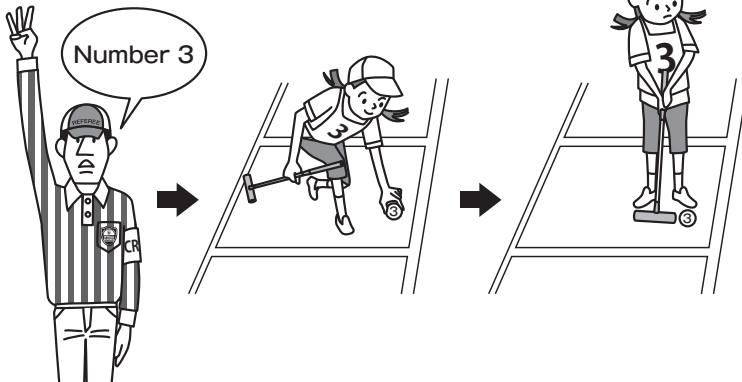

Q

59

What should the referee do when, during a start stroke, a stroker uses his/her stick or foot to draw a ball that is in the free zone into the court, and then strokes that ball without repositioning it with the hand? Also, what should the referee do when, during a start stroke, the stroker strokes his/her ball that has been placed inside the field before the stroke is called without repositioning that ball with the hand after the stroke is called?

A

The referee continues to count 10 seconds, the count of which begins when the stroke is called.

Explanation

1. Only when the manager asks for a reason, the referee responds with the answer "The positioning of the ball was incorrect."
2. As a rule, the ball stroked by the stroker is left as it is, and it is not the responsibility of the referee to stop that ball, even if the referee attempts to stop that ball but fails.
3. There is no need for the referee to pick up or throw back, to the stroker, a ball that has been stroked by the stroker until a foul, such as time over, takes place.
4. If a stroker wants to reposition his/her ball with the hand in the start area and carry out the start stroke once again, that stroker must go and retrieve that ball him/herself. The 10 second count will continue to be applied.
5. When start stroking, the stroker should check his/her ball and place it in the start area using the hand.



Q 60

When the stroker places the ball inside the start area, does it represent placing the ball using the hand inside the court if that stroker uses the hand to throw or roll the ball into the court, or drops the ball that is in the hand onto the ground?

A

When the stroker uses the hand to place the ball in the start area, this would be seen as placing the ball in the start area using the hand at the point that the ball stops.

Explanation

It is not appropriate behavior for a stroker to throw, roll, or drop, inside the court, a ball that is in the hand. The stroker should always use the hand to place the ball on the court.

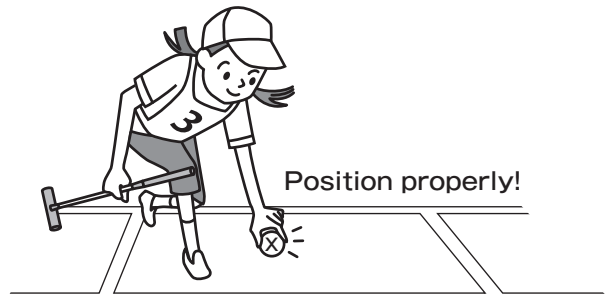
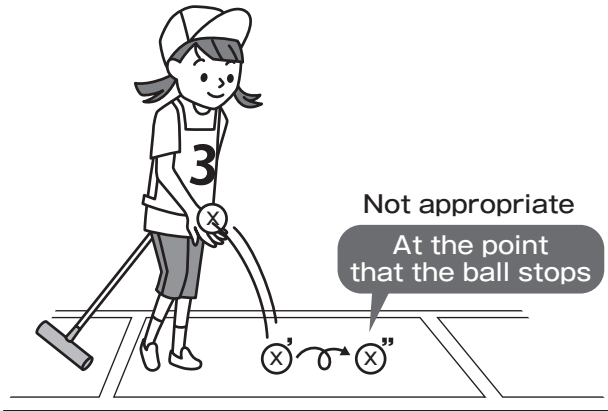

Q 61

When a ball other than the stroker's ball that has not successfully passed through the first gate is mistakenly placed inside the start area using the hand, can it be replaced with the stroker's ball?

A

The other ball can be replaced with the stroker's ball.

Explanation

1. Ten seconds are still counted while the ball is being replaced with the hand.
2. Similarly, even when the other ball is placed in the field but outside the start area, the ball can be replaced, using the hand, with the stroker's ball.
3. It is a stroking foul if the stick comes into contact with another ball placed on the field with the hand, while it is a ball touch foul if the stroker's foot comes into contact with that ball.
4. In the event of a stroking foul or ball touch foul, any balls that have not made a successful pass through the first gate are removed from the field.
5. It is not appropriate behavior to place another ball on the field. Before a start stroke, the stroker should always check the ball and place his/her own ball in the start area.

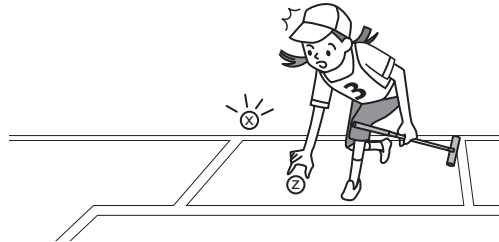

Reference

Article 12, Clause 2, Starting Stroke 1 (1) of the Game Rules:

(Refer to the same rule outlined in Q55.)

Article 12, Clause 4, Stroking Foul 1 (9) of the Game Rules:

"If the stick comes into contact with another stationary ball."

Q
62

For some reason, a ball that hasn't successfully passed through the first gate is on the field, rather than a ball placed by the stroker. Is it a foul if the stroker comes into contact with that ball?

A

It is not a foul.

Explanation

1. If, for some reason, a ball that shouldn't be on the field is on the field, it is not a foul, other than a time over foul, even if the stroker comes into contact with that ball.
2. The referee should quickly remove any balls that have not successfully passed through the first gate or have successfully finished ("Agari") to prevent this situation.

Q
63

Is it a foul if, during a start stroke, the stick comes into contact with the stroker's ball when the stroker is holding that ball in the hand? And after the stroker's ball is placed in the start area using the hand, and the stroker about to reposition the ball, is it a foul if the stroker's stick comes into contact with that ball that has been picked up?

A

Neither situations represent a foul.

Explanation

It is not a foul when a ball that is in the hand comes into contact with the stick after a stroke has been called.



Q 64

During a start stroke, can the stroker ask the referee to temporarily move an in-ball that is obstructing the stroke (the stroker's stance)?

A

Although any balls that are on the front side from the gate line of the first gate to the start area, and any balls that are on the back side within one ball's width from the gate line of the first gate can be temporarily moved, any in-balls that lie beyond this range may not be temporarily moved.

Explanation

1. When the referee is asked by the stroker to temporarily move a ball that is obstructing a pass through the first gate, then marks the position of the ball, and the ball moved to a position that will not obstruct a pass through the first gate.
2. After the start stroke by the stroker, the referee then returns the temporarily moved ball to the position it was in before it was moved.

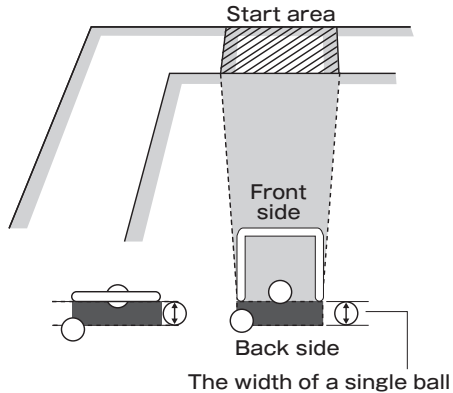
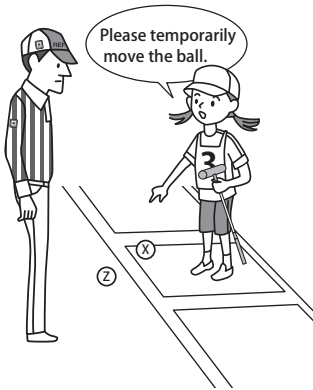

Reference

Article 12, Clause 2, Starting Stroke 1 (2) of the Game Rules:

"A stroker may ask the referee to have a ball temporarily moved if it is obstructing the path to complete a pass through the first gate."

Article 17, Clause 2, Out-ball 3 of the Game Rules:

"A stroker may ask the referee to temporarily remove an out-ball if the stroker feels the ball will obstruct play."

Q 65

Is the stroker's ball deemed as being in the start area if the outer edge of the stroker's ball is placed on the first gate side of the inside line that marks the start area?

A

The ball is not deemed as being placed in the start area.

Explanation

1. If the outer edge of the stroker's ball is placed on the free zone side of the outside line of the start area, then this is deemed as the stroker's ball being placed in the start area.
2. It is a stroking foul if, during a starting stroke, the stroker's ball is placed in the field but outside the start area and then stroked.

- Referee A decides whether the stroker's ball has been placed in the start area.
- Stroking ball ③ and ⑤ is a stroking foul.

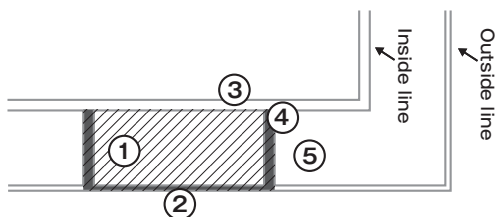

Reference

Article 12, Clause 2, Start Stroking 1 of the Game Rules:

(Refer to the same rule outlined in Q56.)

Q 66

When removing, from the field, a ball that has not made a successful pass through the first gate, where should this ball go?

A

The ball is moved outside the court, near the first gate, but depending on the situation, the ball can be moved outside the court near where the ball was picked up.

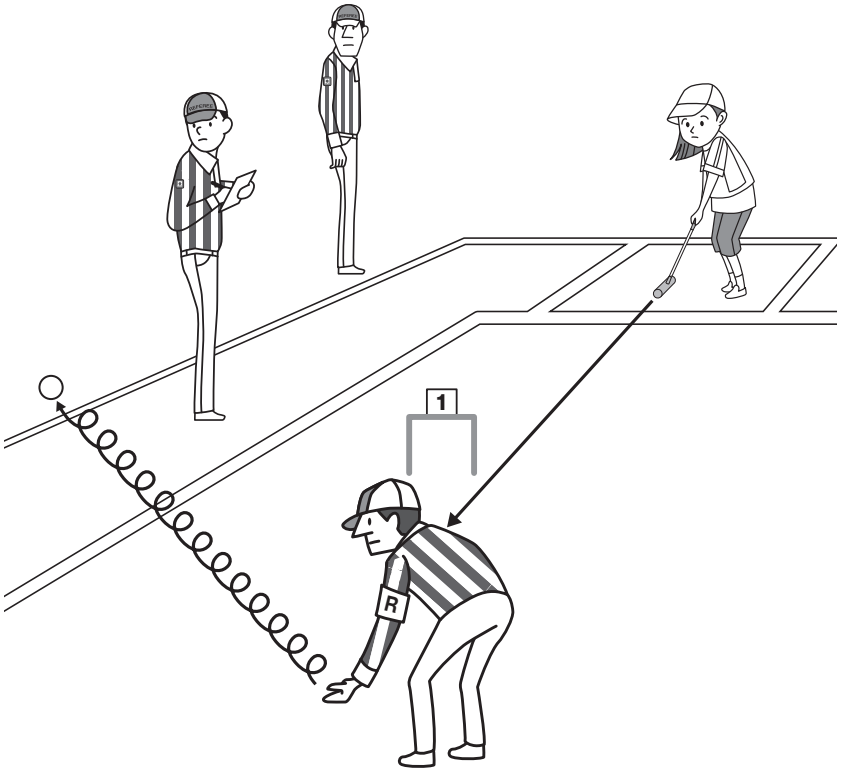

Q 67

During a start stroke, the stroker places his/her ball in the start area, and the force of that move causes the ball to roll and hit the stick face. Does this mark the end of the stroke?

A

It is not the end of the stroke if a stroker's ball that is not stationary hits the stick face.

Explanation

1. When placing the stroker's ball in the start area, the moment that the stroker's ball leaves the hand and stops in the start area represents the stroker's ball being placed in the start area.
2. The force of the move causing the ball to roll and hit the stick face means that the stroker's ball that has left the hand hits the stick face before stopping, and therefore is something that takes place before the stroker's ball is positioned.
3. If the stick face comes into contact with the stationary stroker's ball in the start area, then this marks the end of the stroke, while it would be a stroking foul if the stroker's ball comes into contact with any other part of the stick other than the face.
4. If a stationary stroker's ball moves and comes into contact with the stroker's stick or foot as the result of the way the lines marking the inside line and start area have been set, this does not represent a stroke or a foul, but an invalid move, and the stroker's ball is returned to the position it was in before it moved.



Reference

Article 11, Clause 2, Invalid Moves 1 (10) (v) of the Game Rules:

"When a stationary ball moves as the result of weather conditions, or as the result of the way the gate, the goal pole, the inside line, or the lines forming the start area have been set."

Article 12, Clause 1, Stroking 1 of the Game Rules:

"Stroking refers to the act of a stroker stroking his/her own ball with the face of the stick."

Gaining the Right for Continuous Stroke

Q
68

When can a stroker's ball be stroked twice in succession?

A

A stroker's ball can be stroked twice in succession after a successful Spark following a successful Pass Touch (Touch Pass) through the second or third gate.

Explanation

Regardless of whether it is a Pass Touch or Touch Pass that has taken place, the stroker's ball can be stroked twice in succession as long as another ball that has been touched is successfully sparked.

Pass Touch

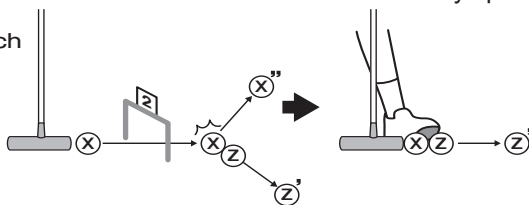

Touch Pass

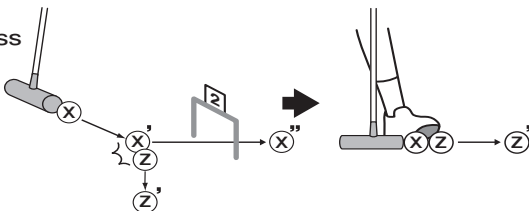

Reference

Article 12, Clause 3, Gaining the Right for Continuous Stroke 1 (3) of the Game Rules:

"When a successful pass through a gate and a successful Touch are made with the same stroke, the stroker can stroke his/her ball two times more after making a successful Spark."

Q 69

After a successful Pass Touch and Spark, the first stroke results in a successful Touch with another ball, but that ball then ends up an out-ball. Can the stroker's ball be stroked once more?

A

Yes, it can be stroked once more.

Explanation

A successful Spark after a Pass Touch means that the stroker has the right to stroke his/her ball twice in succession. As the stroker's ball has only been stroked once, the stroker can then stroke his/her ball once more.

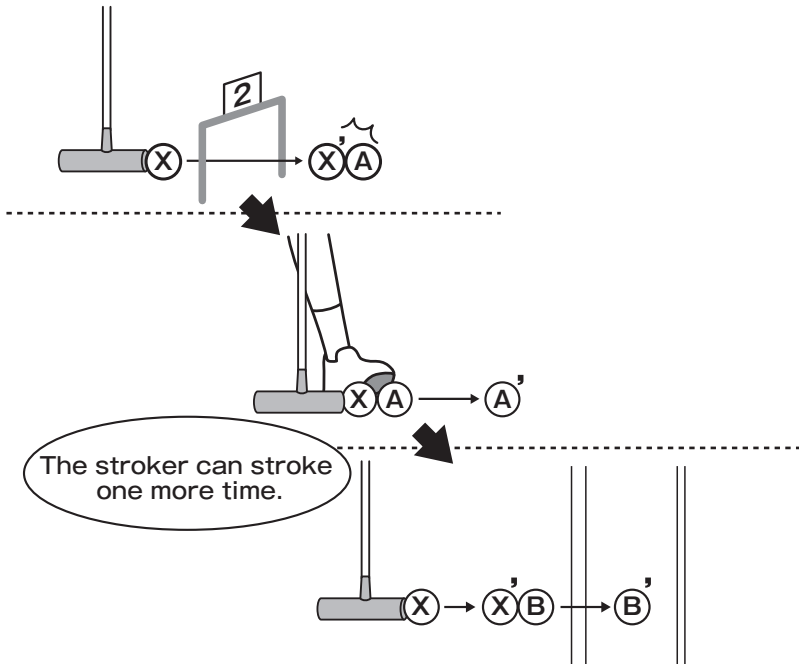

Reference

Article 12, Clause 3, Gaining the Right for Continuous Stroke 1 (3) of the Game Rules:

(Refer to the same rule outlined in Q68.)

Q 70

A successful Pass Touch has taken place, but the touched ball ends up an out-ball. How many times can the stroker's ball be stroked?

A

The stroker's ball can be stroked once.

Explanation

The touched ball becomes an out-ball, and therefore may not be sparked. Even if a successful Pass Touch takes place, the stroker can only stroke his/her ball once.

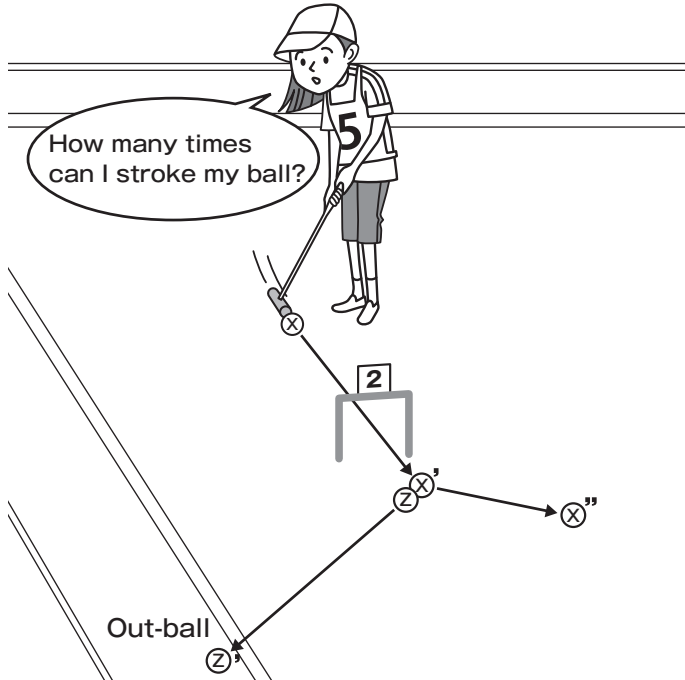

Reference

Article 12, Clause 3, Gaining the Right for Continuous Stroke 1 (1) of the Game Rules:

"When the stroker's ball makes a successful pass through a gate and stops as an in-ball, the stroker can stroke his/her ball once more. The number of continuous strokes gained by making one or more successful passes through one or more gates is limited to one."

Q 71

After a successful Touch with ball A and ball B in a single stroke, a successful Spark is achieved with ball A and ball B. After this, the stroker attempts a finish ("Agari") of his/her ball (which made a successful pass through the third gate), when the stroker achieves a successful Touch with ball C (which made a successful pass through the third gate). Ball C then moves to hit the goal-pole, resulting in a successful finish ("Agari"). Although the stroker's ball has not yet hit the goal-pole, can the stroker stroke his/her ball one more time? Also, if ball C becomes an out-ball, can the stroker stroke his/her ball one more time?

A

The right for continuous stroke is not gained in either of the above examples.

Explanation

1. As ball A and ball B have been successfully sparked, the right for continuous stroke allows the ball to be stroked once only.
2. If ball C either achieves a successful finish ("Agari"), or becomes an out-ball, it may not be sparked. Therefore, the right for continuous stroke does not apply to the stroker's ball.

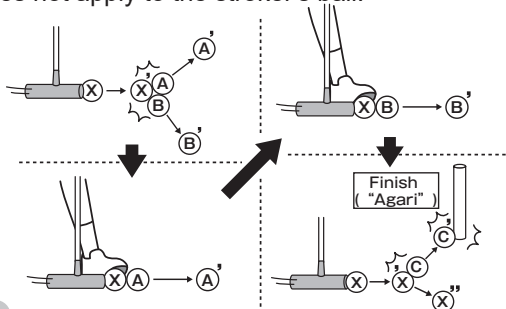

Reference

Article 12, Clause 3, Gaining the Right for Continuous Stroke 1 (2) of the Game Rules:

"When a Spark is made successfully, the stroker can stroke his/her ball once more. The number of continuous strokes gained by making one or more successful Sparks is limited to one."

Q 72

After a successful Touch with ball A and ball B in a single stroke, a successful finish ("Agari") of ball A is achieved. How many times can the stroker's ball be stroked after achieving a successful Spark of ball B? Also, if ball A which has been successfully touched ends up on the outer field, how many times can the stroker's ball be stroked?

A

In both situations, the stroker's ball can be stroked once.

Explanation

As ball B has been successfully sparked, even though ball A achieves a successful finish ("Agari"), or ends up on the outer field, the stroker's ball can only be stroked once.

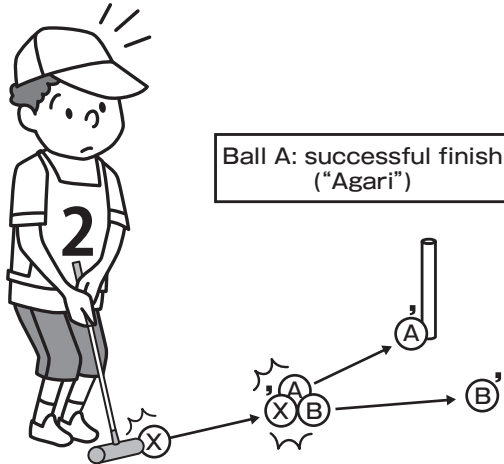

Reference

Article 12, Clause 3, Gaining the Right for Continuous Stroke 1 (2) of the Game Rules:

(Refer to the same rule outlined in Q71.)

Q
73

If a successful Pass Touch (Touch Pass) through the second gate has been achieved, and a successful Pass Touch (Touch Pass) through the third gate is achieved with the next stroke, how many times can the stroker's ball be stroked?

A

The stroker's ball can be stroked three times after a successful Spark.

Explanation

If a stroker who has the right to stroke his/her ball twice in succession strokes that ball towards the third gate, that stroker then has the right to stroke once more. If, following a successful Spark, the stroker's ball achieves a successful Pass Touch (Touch Pass) with ball B at the third gate, the stroker gains the right to stroke his/her ball twice. Therefore the stroker's ball can be stroked a total of three times.

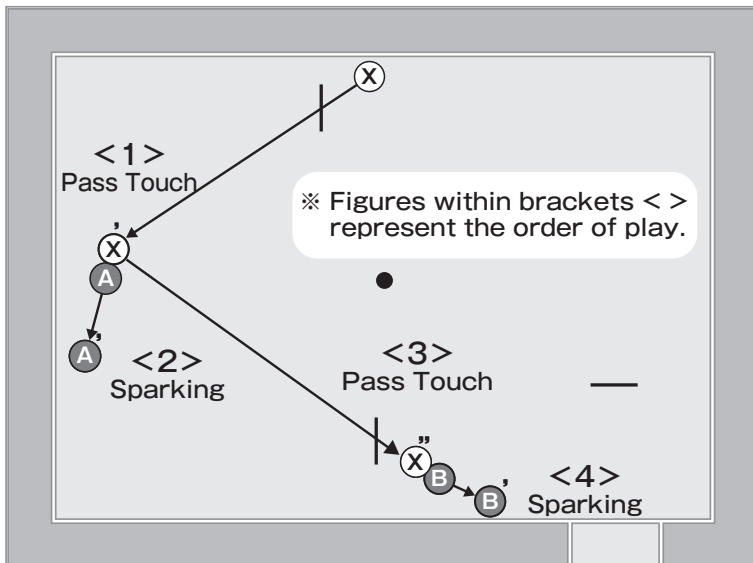

Reference

Article 12, Clause 3, Gaining the Right for Continuous Stroke 1 (3) of the Game Rules:

(Refer to the same rule outlined in Q68.)

Article **12** **Stroking**

Clause **4** **Stroking Foul**

Q
74

What does pushing refer to?

A

Pushing refers to pushing one's ball while the stick face remains in contact with the stroker's ball. This represents a stroking foul.

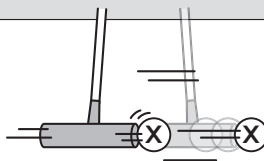

Reference

Article 12, Clause 4, Stroking Foul 1 (1) of the Game Rules:

"Stroking by pushing (when the face of the stick pushes the stroker's ball forward while keeping the stick face in contact with the ball)."

Q
75

What does stroking the ball twice refer to?

A

Stroking the ball twice refers to the stick face coming into contact with the stroker's ball two or more times during the same swing, and is a stroking foul. It can take place when the stroker's ball hits a ball or gate leg and bounces back.

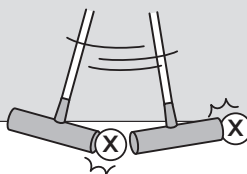

Reference

Article 12, Clause 4, Stroking Foul 1 (2) of the Game Rules:

"When a ball is stroked twice (when the stick face touches the stroker's ball twice or more during the same swing)."

Q 76

A Spark is successful if the outer edge of the sparked ball ends up 10 cm or more away from the outer edge of the stroker's ball. Therefore, can the stroker's ball be stroked even while the sparked ball is moving?

A

The stroker's ball may not be stroked while the sparked ball is moving.

Explanation

1. If the stroker's ball is stroked while the sparked ball is moving, this is a stroking foul, and the stroker's ball is returned to the position it was in before it moved (when stroked).
2. Even after a successful Spark, and the stroker has finished sparking, the stroker doesn't gain the right for continuous stroke until the sparked ball stops moving.

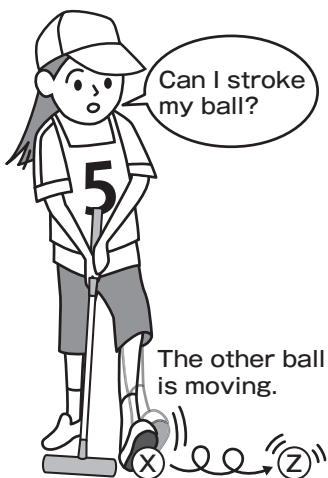

Reference

Article 12, Clause 3, Gaining the Right for Continuous Stroke 1 of the Game Rules:

"The right for continuous stroke is gained in the following cases where all the balls inside the inner field stop."

Article 12, Clause 3, Gaining the Right for Continuous Stroke 1 (2) of the Game Rules:

"When a Spark is made successfully, the stroker can stroke his/her ball once more. The number of continuous strokes gained by making one or more successful Sparks is limited to one."

Article 12, Clause 4, Stroking Foul 1 (8) of the Game Rules:

"Following a successful Spark, when stroking the stroker's ball before all the balls inside the inner field come to a stop."

Article 16, Clause 3, Completions of Sparking, 1 (1) of the Game Rules:

"When the outer edge of the other sparked ball is 10 cm or more away from the outer edge of the stroker's ball."

Q
77

If a stroke is carried out while swinging the stick between the stroker's legs, and the stick head comes into contact with the foot, does it represent a stroking foul of kicking the stick to stroke the ball?

A

It is not a stroking foul if the stick head comes into contact with the foot.

Explanation

The stick head coming into contact with the foot, and the stick head being kicked in order to stroke, are two completely different things.

Reference

Article 12, Clause 4, Stroking Foul 1 (4) of the Game Rules:

"When the stroker kicks his/her stick to stroke his/her ball."

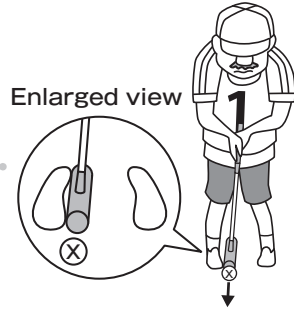

Q
78

Is it still a stroking foul if the hand is used to strike the shaft?

A

It is a stroking foul to hit any part of the stick to stroke, regardless of whether it is kicked, or struck with the hand.

Explanation

1. Like hitting the stick head with the hand, hitting the shaft with the hand is not a proper play.
2. The stroker loses his/her right to stroke, and the ball is returned to the position it was in before it was stroked.

Reference

Article 12, Clause 4, Stroking Foul 1 (5) of the Game Rules:

"When the stroker's ball is stroked by using the hand to hit the stick."

Article 12, Clause 4, Stroking Foul 1 (6) of the Game Rules:

"When the stroker's ball is stroked while the hand is in contact with the head of the stick."



Q 79

After a stroker has achieved a Touch with balls A and B with a single stroke, followed by a successful Spark with ball A, the stroker then strokes his/her ball without sparking ball B. What should the referee do?

A

Ball A which has been successfully sparked remains where it stopped after being sparked, while ball B which wasn't sparked remains where it stops following the Touch, while the stroker's ball becomes an out-ball from the position(where it stopped after the Touch).

Explanation

1. This is a stroking foul during the stroker's action on sparking.

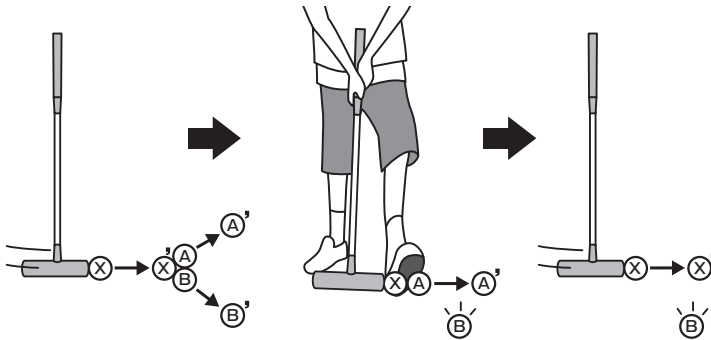

Reference

Article 12, Clause 4, Stroking Foul 1 (11) of the Game Rules:

"When stroking the stroker's ball without sparking although the right to spark is gained."

Q 80

As the stroker is stroking his/her ball with the stick face, the ball jumps so that it hits a part of the stick other than the stick face during the swing. Is this a stroking twice foul?

A

Although it is a stroking foul, it is not a stroking twice foul. It is a foul that applies to situations in which the stick comes into contact with a stroker's ball that is still moving.

Explanation

1. As it is not the face but the shaft of the stick that comes into contact with the stroker's ball for the second time, the stroking twice foul does not apply.
2. The stroker's ball becomes an out-ball from where it was when it came into contact with the part of the stick other than the stick face (the illustration shows a case when the stick comes into contact with the shaft of the stick).

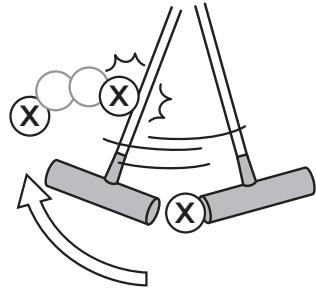

Reference

Article 12, Clause 4, Stroking Foul 1 (14) of the Game Rules:

"If the stroker's stick comes into contact with his/her ball that is moving (excluding when a ball is stroked twice)."

Q 81

A stroker swings slowly to stroke his/her ball when the ball hits the leg of the gate that is 10 cm ahead, bounces back, and then hits the stick face, all during the same swing. Is this a stroking twice foul?

A

As the stroker's ball that bounced back hit the stick face during the same swing, this is a stroking foul.

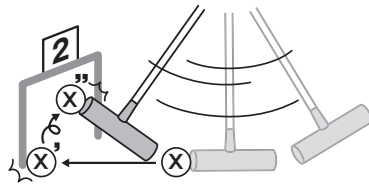

Explanation

1. The stroker's ball to which the stroking foul is applied is returned to the position it was in before it moved.
2. A swing refers to the series of actions following the address of the ball, from take back, to forward swing, impact and follow through (although a take back is not always carried out). The swing ends with the completion of the follow through.
3. If, after the swing, the stroked stroker's ball bounces back to hit the stick that is no longer moving, regardless of which part of the stick the stroker's ball hits, it is the same as a stroker's ball being stroked while it is still moving. Therefore, the stroker's ball becomes an out-ball from where it hit the stick after bouncing back.
4. Although it is a stroking foul to stroke twice as well as to stroke one's ball while it is moving, as the two situations are dealt with differently, the referee must be careful in making his/her final decision.

Reference

Article 12, Clause 4, Stroking Foul 1 (2) of the Game Rules:

(Refer to the same rule outlined in Q75.)

Article 12, Clause 4, Stroking Foul 1 (14) of the Game Rules:

(Refer to the same rule outlined in Q80.)

Q
82

After a successful Spark, and before the stroker strokes his/her ball, the stick comes into contact with the sparked other ball. What sort of foul is this?

A It is a stroking foul.

Explanation

The ball that moved as the result of the stroking foul is returned to the position it was in (where it stopped following the Spark).

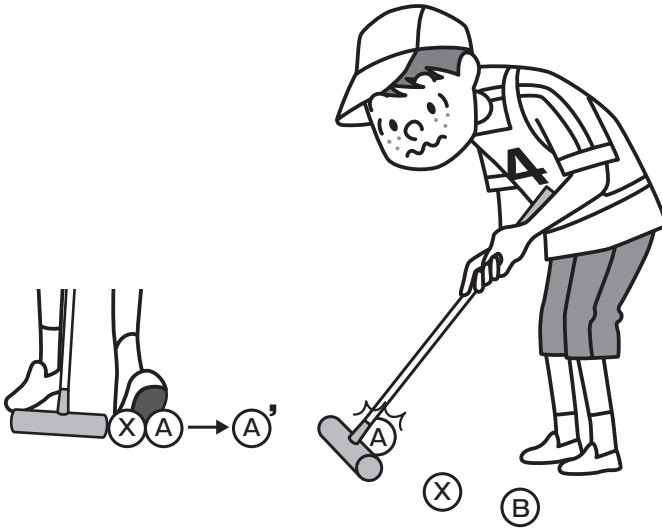

Reference

Article 12, Clause 4, Stroking Foul 1 (9) of the Game Rules:
"If the stick comes into contact with another stationary ball."

Q 83

Although it is a foul to use the stick to move a touched ball towards the stroker, is it still a foul if the stroker has no intention of moving the ball towards him/her, but the stick just happens to come into contact with that ball?

A

This is a stroking foul during the stroker's actions on sparking, whether it is the stroker's intention to bring the ball forward or not.

Explanation

The touched ball is returned to the position it was in (where it stopped following the Touch) before it moved, and the stroker's ball becomes an out-ball from the position where it stopped after the Touch.



Reference

Article 12, Clause 4, Stroking Foul 1 (9) of the Game Rules:

(Refer to the same rule outlined in Q82)

Article 12, Clause 4, Stroking Foul 2 (5) of the Game Rules:

"If a stroking foul takes place during a stroker's action on sparking, Article 16, Clause 4, Sparking Foul 2 shall apply, depending on the situation at the time."

Q

84

During a start stroke, is it a foul if the stroker's ball, which has been placed in the start area using the hand, is repositioned with the stick?

A

It can be the end of the stroke, or a stroking foul, depending on which part of the stick comes into contact with the stroker's ball.

Explanation

1. If the stick face is used to reposition the stroker's ball, then this marks the end of the stroke.
2. If any part of the stick other than the face is used to reposition the stroker's ball, this represents a stroking foul.

It is a foul if any part of the stick other than the face is used to draw the stroker's ball towards the stroker.

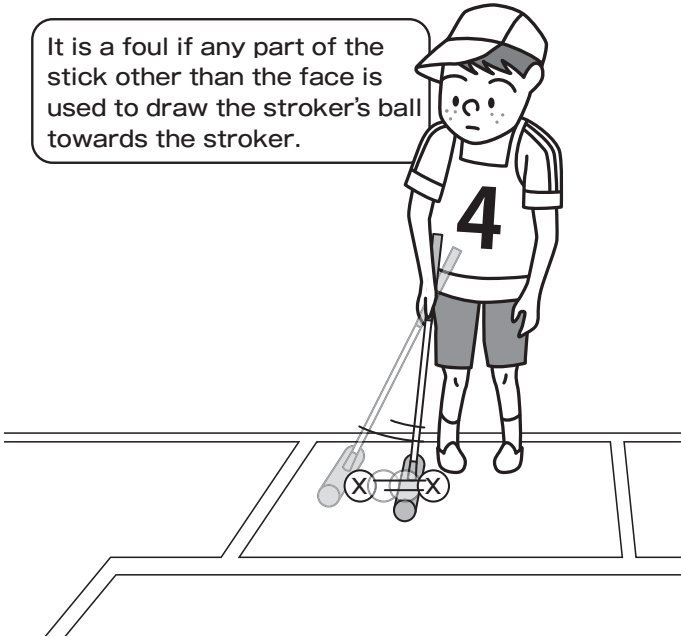

Reference

Article 12, Clause 4, Stroking Foul 1 (3) of the Game Rules:

"When the stroker's ball is stroked with a part of the stick other than the stick face."

Q
85

Is it a foul if the stroker is holding the touched ball, and the stick comes into contact with that ball?

A It is not a foul.

Explanation

As long as the touched ball is in the hand, it is not a foul even if the stick comes into contact with that touched ball.



Q

86

Is it a stroking foul or a ball touch foul if the stick comes into contact with a touched other ball that is still moving?

A

It is a ball touch foul if the stick comes into contact with another ball that is moving.

Explanation

1. A ball that moves as the result of a stroking foul is returned to the position it was in when it came into contact with the stick, and the stroker's ball becomes an out-ball from the position it stopped in following the Touch.
2. If the touched ball isn't moving, but has stopped as an in-ball, and the stick then comes into contact with that ball, this represents a stroking foul during the stroker's actions on sparring. The ball that moved as the result of the stroking foul is returned to the position it was in before it moved (where it stopped following the Touch), and the stroker's ball becomes an out-ball from where it stopped following the Touch.

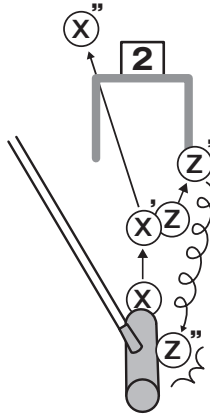

Reference

Article 12, Clause 4, Stroking Foul 1 (9) of the Game Rules:

(Refer to the same rule outlined in Q82.)

Article 12, Clause 4, Stroking Foul 1 (13) of the Game Rules:

"If the stick comes into contact with another ball that is moving."

Article 12, Clause 4, Stroking Foul 2 (5) of the Game Rules:

(Refer to the same rule outlined in Q83.)

Q 87

Is it a stroking foul if, during a start stroke, the stroker strokes his/her ball after it completely crosses over the gate line of the first gate but before it stops on the inner field?

A

It is a stroking foul. The stroker's ball becomes an out-ball from the position where the stroker stroked it.

Explanation

It is a stroking foul as the stroker's ball has made a successful pass through the first gate.



Reference

Article 12, Clause 4, Stroking Foul 1 (14) of the Game Rules:

(Refer to the same rule outlined in Q80.)

Article 13, Clause 1, Successful Pass Through a Gate 1 (1) of the Game Rules:

"A pass through the first gate is successful if the stroker's ball completely passes over the gate line of the first gate with the start stroke."

Article **13**

Passing the Gate("Gate Tsuka")

Clause **1**

Successful Pass Through a Gate

Q

88

What represents a ball completely crossing over the gate line?

A

A ball completely crosses over the gate line when the ball moves from the front side of the gate to the back side, and the outer edge of the ball completely crosses over the gate line.

Explanation

The gate line refers to the imaginary straight line that joins both legs of the gate at the back.

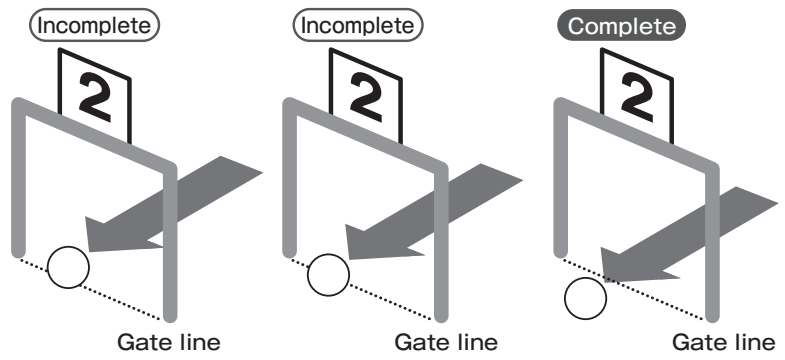

Viewed from directly above

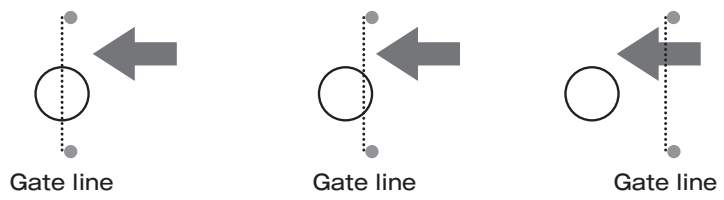

Q
89

After stroking his/her ball, the stroker's foot comes into contact with another stationary ball before the stroker's ball, which is still moving, passes through the gate. Although the stroker's ball then passes through the gate, does this represent a successful pass through the gate?

A

This represents a successful pass through the gate.

Explanation

1. As the movement of the ball is the result of proper play, the movement of the stroker's ball remains valid until the ball stops.
2. As it is a ball touch foul when the stroker's foot comes into contact with another ball, this ball is returned to the position it was in before making contact with the stroker's foot.

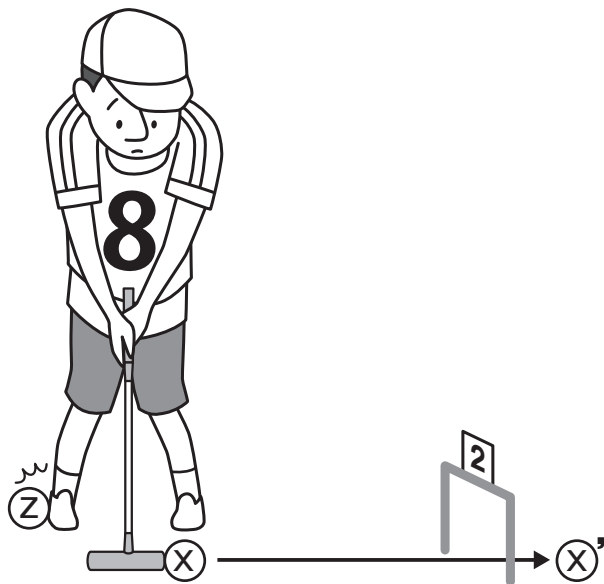

Reference

Article 18, Clause 1, Ball Touch Foul 2 (1) of the Game Rules:

"If a stroker comes into contact with a stationary ball."

Q 90

A ball moves from the front side of the gate to the back side of the gate through which the ball is to pass through next. After completely crossing over the gate line, it hits another ball and bounces back to stop on the gate line. Is this regarded as a successful pass through the gate? Under the same conditions, if the ball passes over the gate line but doesn't stop, and instead moves to the front side and stops, is this also regarded as a successful pass through the gate?

A It is a successful pass through the gate in both situations.

Explanation

A gate pass is successful if a ball that is moving from the front side completely crosses over the gate line.

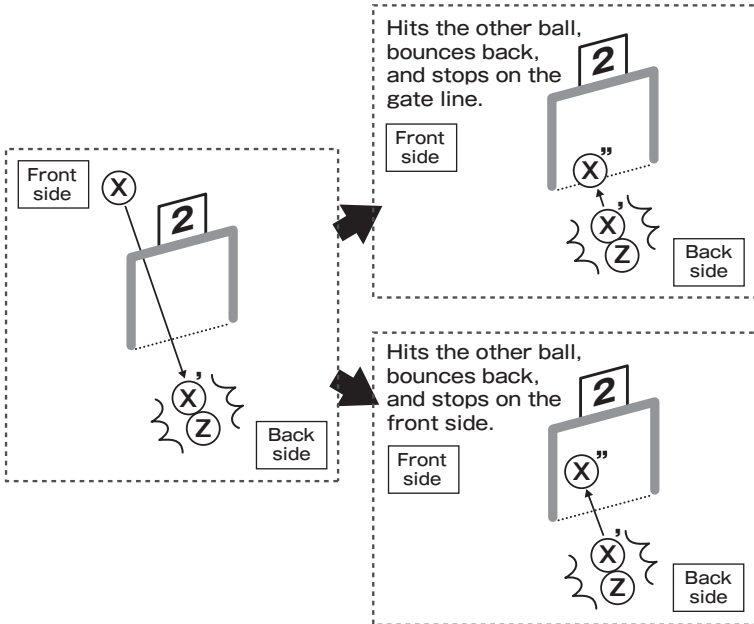

Reference

Article 13, Clause 1, Successful Pass Through a Gate 1 of the Game Rules:

"A successful pass through a gate, or "Gate Tsuka," takes place when the ball moves in the direction from the front side to the back side, through the first, second and third gates, in that order, to completely cross over the gate line for the first time."

Q
91

During a start stroke, the ball completely crosses over the gate line of the first gate, and then hits another ball. Does this represent a successful pass of the stoker's ball through the first gate?

A

It is a successful pass through the first gate.

Explanation

1. A Touch is not successful even if the start stroke results in a successful pass through the first gate and then the stoker's ball hits a stationary ball on the inner field.
2. The stoker's ball and the other ball shall remain where they stopped moving.
3. A Touch is successful if the stoker's ball hits a ball as the result of a continuous stroke.

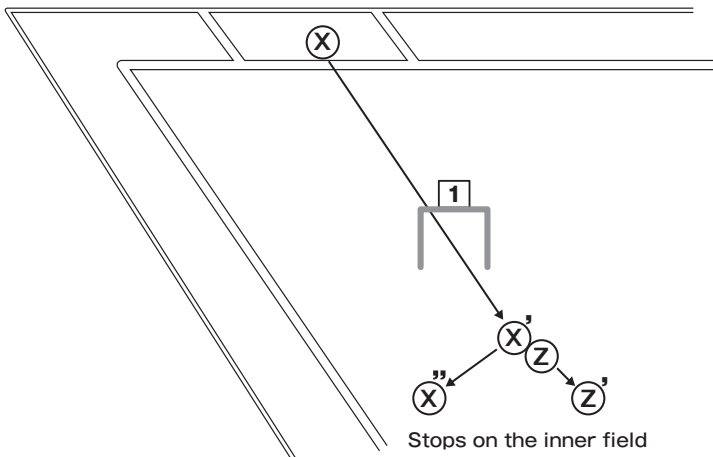

Reference**Article 13, Clause 1, Successful Pass Through a Gate 1 (1) of the Game Rules:**

"A pass through the first gate is successful if the stroker's ball completely passes over the gate line of the first gate with the start stroke."

Article 15, Clause 1, A Successful Touch 1 of the Game Rules:

"A Touch occurs when the stroker's ball that is an in-ball is stroked and moves to touch another ball."

Q
92

During a start stroke, the stroker's ball hits the right leg of the first gate, then completely crosses over the gate line of the first gate, to stop on the gate line of the second gate. After this, if, as a result of continuous stroke, the stroker's ball crosses over the gate line of the second gate and moves to the back side of the gate, does this represent a successful pass of the stroker's ball through the second gate? Similarly, if the stroker's ball stroked during a start stroke passes completely over the gate line of the first gate, and continues to pass over the gate line of the second gate, and stops on the inner field without entering the outer field, does this represent a simultaneous and successful pass of the stroker's ball through the first and second gates?

A

Both situations represent a successful pass through the second gate of the stroker's ball.

Explanation

1. A successful pass through the first gate takes place when a stroker's ball that has moved as the result of a start stroke completely passes over the gate line of the first gate.
2. The stroker's ball has successfully crossed through the second gate if, as the result of 1, the stroker's ball stops on the gate line of the second gate, and in the continuous stroke completely passes over

the gate line of the second gate.

3. A successful pass through the first and the second gates by the stroker's ball takes place when a stroker's ball that has moved as the result of a start stroke completely passes over the gate line of the first gate and then completely passes over the line of the second gate. In this case, the stroker can stroke once more if the ball stops in the inner field without going onto the outer field.

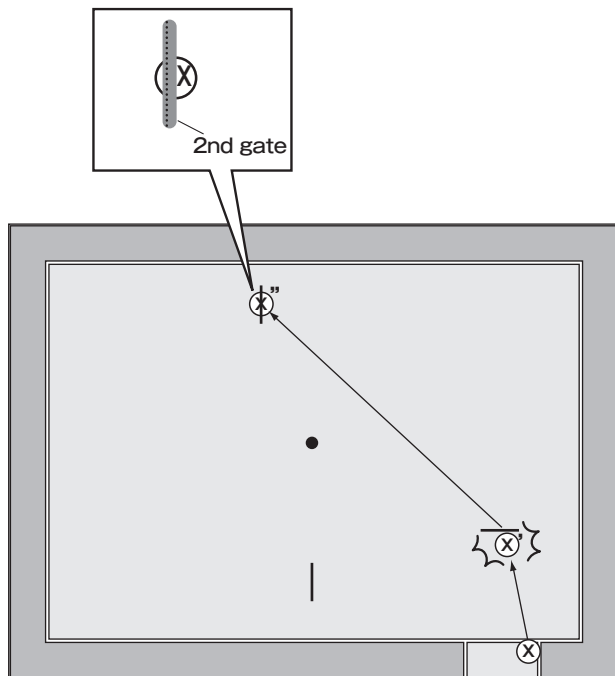

Reference

Article 12, Clause 3, Gaining the Right for Continuous Stroke 1 (1) of the Game Rules:

"When the stroker's ball makes a successful pass through a gate and stops as an in-ball, the stroker can stroke his/her ball once more. The number of continuous strokes gained by making one or more successful passes through one or more gates is limited to one."

Article 13, Clause 1, Successful Pass Through a Gate 1 (1) of the Game Rules:

(Refer to the same rule outlined in Q91)

Q
93

During a start stroke, is it a successful pass through the first gate if the stroker's ball completely crosses over the gate line of the first gate, then after first entering the outer field, moves back onto the inner field because of the surface conditions and stops?

A

It is a successful pass through the first gate.

Explanation

The stroker's ball becomes an out-ball from the position it passed over the inside line into the outer field.

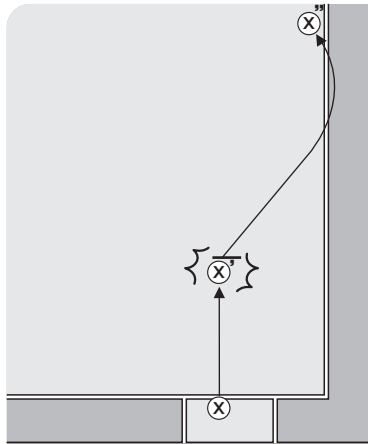

Reference

Article 13, Clause 1, Successful Pass Through a Gate 1 (1) of the Game Rules:

(Refer to the same rule outlined in Q91)

Article 17, Clause 2, Out-ball 1 (1) (i) of the Game Rules:

"A ball which goes to the outer field after successfully passing through the first gate as a result of a start stroking."

Q 95

A ball which has made a successful pass through the first gate moved from the back side of the second gate and stopped on the gate line. A stroker's ball which moved from the back side of the gate hits this ball, resulting in a successful Touch, then stops at the front side of the second gate. As this results in the stroker gaining the right to spark, the other ball is set so that it isn't on the gate line of the second gate and then sparked. The sparked ball completely crosses over the gate line of the second gate. Does this represent a successful pass of that ball through the second gate?

A

Yes, it is a successful pass through the second gate.

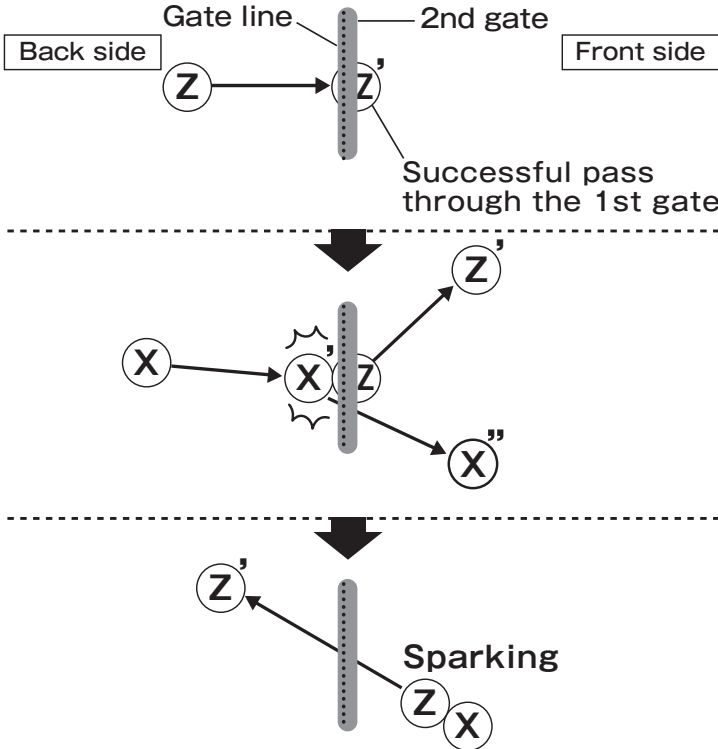

Explanation

1. This is similar to the stroker's ball slide touching another ball that is at the back side of the second gate, causing the stroker's ball to move to the front side of the second gate, after which the touched other ball is sparked, resulting in a successful pass through the second gate.
2. The same applies to a ball that was an out-ball and moved on the gate line of the second gate as the result of the stroking of an out-ball, or to a ball that was placed on the gate line as the result of a foul that took place after being set but before a successful Spark is achieved. In both cases, if the ball is touched by the stroker's ball to move to the front side of the second gate, set so that it isn't on the gate line of the second gate and then sparked to completely cross over the gate line of the second gate, it is deemed a successful pass of the sparked ball through the second gate.

Reference**Article 11, Clause 1, Valid Moves 1 of the Gateball Rules:**

"Aside from invalid moves, all movements of balls as a result of a proper play by a stroker shall be valid."

Article 16, Clause 1, Spark 2 of the Gateball Rules:

"Setting the balls refers to stepping on the stroker's own ball where the ball has stopped, and placing a touched ball inside the inner field so that it is in contact with the stroker's ball."

Q

96

When the stroker's ball (which made a successful pass through the first gate) is stroked, that ball completely crosses over the gate line of the second gate from the front side and keeps moving to result in a "touching the same ball twice" foul at the back side of the gate. Does this represent a successful pass of the stroker's ball through the second gate?

A

Yes, the stroker's ball has made a successful pass through the second gate.

Explanation

1. As the foul takes place after the ball completely crossed over the gate line of the second gate, it is a successful pass through the gate.
2. The ball that has moved after being touched twice is returned to the position it was in before it moved, while the stroker's ball becomes an out-ball from where it was when touched twice.
3. It is not a successful pass through the gate if the "touching the same ball twice" foul takes place before the ball has completely crossed over the gate line of the second gate.

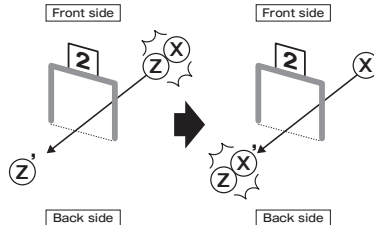

Reference

Article 15, Clause 4, Touching the Same Ball Twice 2 (i) of the Game Rules:

"A ball that has moved as the result of being touched a second time is returned to the position it was in before it moved."

Article 15, Clause 4, Touching the Same Ball Twice 2 (ii) of the Game Rules:

"The stroker's ball becomes an out-ball from the position it was in when it touched twice."

Q 97

Sparked ball A hits ball B (which has made a successful pass through the first gate), and ball B then completely crosses over the gate line of the second gate. However, as the distance between the outer edge of sparked ball A and the outer edge of the stoker's ball is less than 10 cm, this has resulted in a sparking foul. Has ball B made a successful pass through the second gate?

A

Ball B has not made a successful pass through the second gate.

Explanation

As ball B moved as a result of a foul, it is returned to the position it was in before it moved, while ball A is placed where it was set, and the stoker's ball becomes an out-ball from the position it stopped in following the Touch.

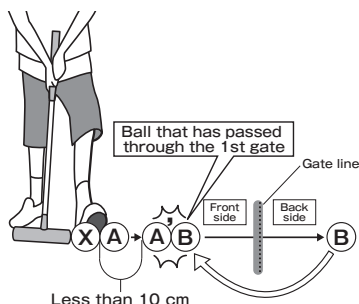

Reference

Article 11, Clause 2, Invalid Moves 1 (1) of the Game Rules:

"The movement of a ball following a foul play."

Article 16, Clause 4, Sparking Foul 2 (2) (i) of the Game Rules:

"A ball that has moved as the result of a sparking foul is returned to the position it was in before it moved."

Article 16, Clause 4, Sparking Foul 2 (2) (ii) of the Game Rules:

"The set other ball shall be in the position where it was when it was set."

Article 16, Clause 4, Sparking Foul 2 (2) (iii) of the Game Rules:

"The stoker's ball becomes an out-ball from the position where it stopped after the Touch."

Q
98

A stroker's ball which has successfully passed through the first gate is stroked and then hits the goal-pole. At this time, another ball (which has successfully passed through the third gate) is in contact with the goal-pole, but this ball does not move. Does this represent a successful finish ("Agari") of the ball?

A

It is not a successful finish ("Agari") of the ball.

Explanation

1. It is a successful finish ("Agari") of the ball if the stroker's ball directly hits the ball in contact with the goal-pole (and which has made a successful pass through the third gate), or if the stroker's ball simultaneously hits that ball and the goal-pole.
2. If another ball in contact with the goal-pole then moves, it is a valid move and remains in the position it stopped at.

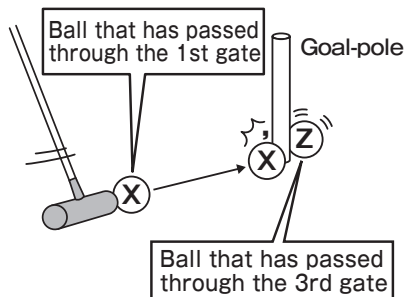
**Reference****Article 11, Clause 1, Valid Moves 1 of the Game Rules:**

"Aside from invalid moves, all movements of balls as a result of a proper play by a stroker shall be valid."

Q 99

A stroker's ball that has successfully passed through the third gate is stroked, resulting in a successful Touch with another ball, and the stroker's ball goes on to hit the goal-pole. Can the stroker spark that ball?

A

The stroker may not spark that ball.

Explanation

Although a successful Touch with the ball has been achieved, as the stroker's right to stroke ends with the successful finish ("Agari") of his/her ball, the touched ball remains in the position it was in after it stopped following the Touch.

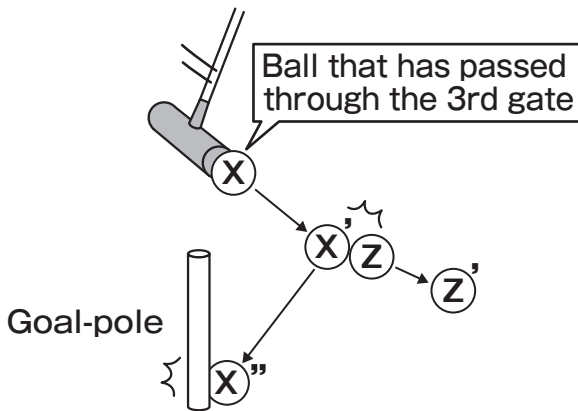

Reference

Article 14, Clause 1, A Successful Finish ("Agari") 2 of the Game Rules:

"A ball that has successfully finished shall be removed from the field."

Article 15, Clause 2, Gaining the Right to Spark 1 of the Game Rules:

"The stroker gains the right to spark when a successful Touch is made, both the stroker's ball and the touched ball stop as in-balls, and all the other balls in the inner field stop."

Q 100

Can multiple balls achieve a finish ("Agari") simultaneously?

A

The following are examples of multiple finishes ("Agari").

1. If the stroker's ball which is an in-ball (and which has successfully passed through the third gate) touches another ball (that has also successfully passed through the third gate), and then both the stroker's ball and the other ball hit the goal-pole.

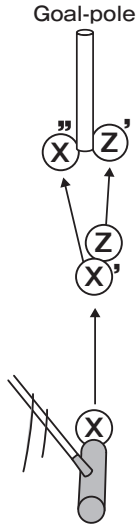

2. If ball A that (which has successfully passed through the third gate) is sparked, and ball A hits ball B (which has successfully passed through the third gate), and then both ball A and ball B hit the goal-pole.

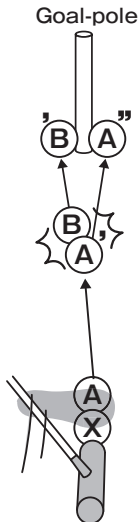

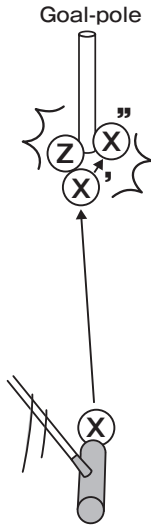

3. If a ball (which has successfully passed through the third gate) is in contact with the goal-pole, and the stoker's ball which is an in-ball (and which has successfully passed through the third gate) touches that ball, after which the stoker's ball hits the goal-pole.

4. If a ball (which has successfully passed through the third gate) is in contact with the goal-pole, and the stoker's ball which is an in-ball (and which has successfully passed through the third gate) simultaneously hits that ball and the goal-pole.

Q 101

Ball A, which is an in-ball (and which has made a successful pass through the third gate) hits the goal-pole which ball B (which has made a successful pass through the third gate) is in contact with. Ball B hasn't hit ball A. Does this represent a successful finish ("Agari") of ball A and ball B?

A

Although this is a successful finish ("Agari") of ball A, it is not a successful finish ("Agari") of ball B. Ball B's movement represents an invalid move, and it is returned to the position it was in before it moved.

Explanation

The movement of ball B is invalid at the moment ball A hits the goal-pole, and therefore it is not a successful finish ("Agari") of ball B.

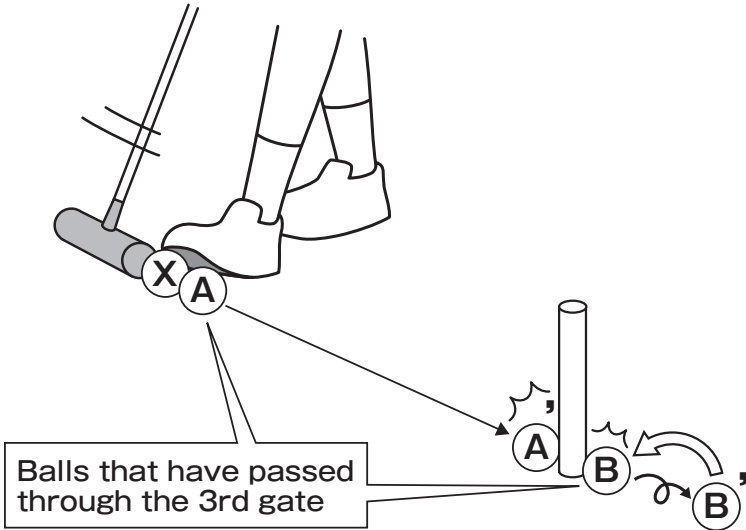

Reference

Article 11, Clause 2, Invalid Moves 1 (6) of the Game Rules:

"Moving a ball that has finished, and other ball(s) moved as a result of this move."

Article **15** **Touch**

Clause **1** **A Successful Touch**

Q
102

When the stroker's ball and another ball are in contact on the inner field, and the stroker then strokes his/her ball away from that ball, is it still a successful Touch if the position of the other ball does not change?

A

It is still a successful Touch.

Explanation

1. Even if the stroker decides that the stroker's ball and the other ball are in contact and strokes the ball assuming that it will be a successful Touch, there is a possibility that the referee thinks that there is no contact, and will decide that it is not a successful Touch.
2. In order to prevent any misunderstanding, the stroker should confirm with the referee whether the move will end in a successful Touch.

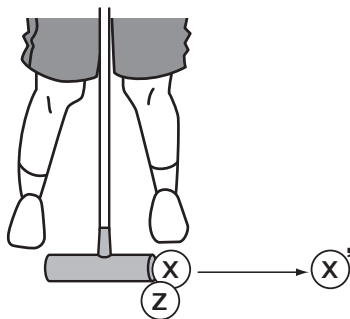

Reference

Article 9, Clause 3, Confirmation by the Stroker 1 (3) (i) of the Game Rules:

"Whether or not the stroker's ball is in contact with the other ball(s) before stroking."

Article 15, Clause 1, A Successful Touch 1 (1) of the Game Rules:

"If the stroker's ball is already in contact with another ball, a successful Touch can be made just by stroking the stroker's ball."

Q 103

During a start stroke, the stroker's ball completely crosses over the gate line of the first gate, and before it stops, it hits another ball on the inner field. After this, both the stroker's ball and the other ball stop on the inner field. Can the ball be sparked?

A

The other ball cannot be sparked.

Explanation

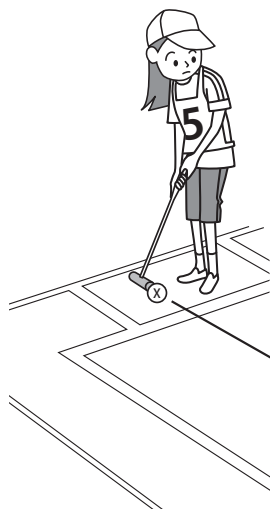

1. It is not a successful Touch.
2. It is a successful pass through the first gate, and the movement of the stroker's ball and the other ball are valid, and therefore they remain where they stopped in after moving.
3. It is a successful Touch if, as the result of continuous stroke, the stroker's ball hits the other ball.
4. Similarly, if, during the start stroke, the stroker's ball hits another ball, and that other ball enters the outer field, the movement of this ball is valid, and it becomes an out-ball.

Reference

Article 11, Clause 1, Valid Moves 1 of the Game Rules:

"Aside from invalid moves, all movements of balls as a result of a proper play by a stroker shall be valid."

Article 15, Clause 1, A Successful Touch 1 of the Game Rules:

"A Touch occurs when the stroker's ball that is an in-ball is stroked and moves to touch another ball."

Q 104

The stroker's ball which is an in-ball hits the gate leg, and the impact results in another ball in contact with the leg of the gate on the other side moving. That ball then hits the stationary stroker's ball. Does this represent a successful Touch?

A

This represents a successful Touch.

Explanation

The movement of the stroker's ball and the other ball is valid, and it represents a successful Touch.

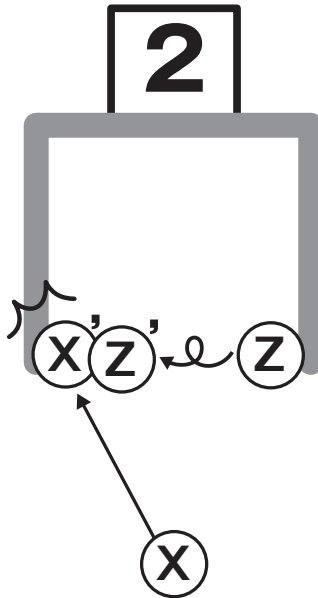

Reference

Article 11, Clause 1, Valid Moves 1 of the Game Rules:

(Refer to the same rule outlined in Q103)

Article **15** **Touch**

Clause **2** **Gaining the Right to Spark**

Q
105

When a successful Touch has been achieved with two balls in a single stroke, does the stroker only gain the right to spark if the stroker's ball and the two balls that were touched by the stroker's ball are all stationary on the inner field?

A

The stroker gains the right for sparking after a successful Touch with two balls even if either of the touched balls becomes an out-ball, as long as the stroker's ball and the other touched balls stop on the inner field.

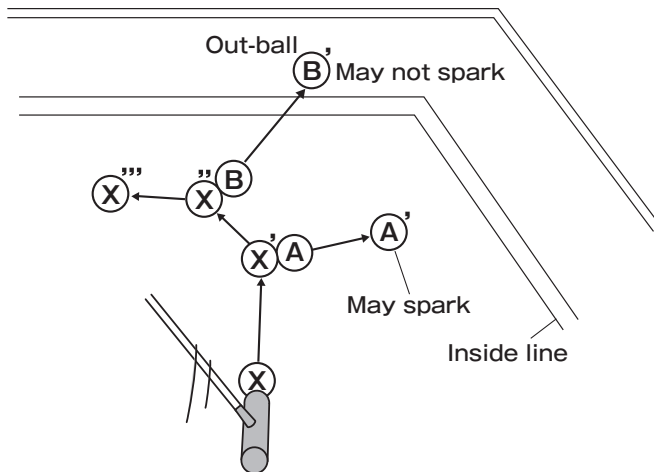

Reference

Article 15, Clause 2, Gaining the Right to Spark 1 of the Game Rules:

"The stroker gains the right to spark when a successful Touch is made, both the stroker's ball and the touched ball stop as in-balls, and all the other balls in the inner field stop."

Q 106

After touched ball A hits ball B, ball B ends up an out-ball. As the stroker's ball and ball A stop on the inner field, does the stroker gain the right to spark ball A?

A The stroker gains the right to spark ball A.

Explanation

1. As the movement of other ball B is valid, other ball B becomes an out-ball.
2. Similarly, if touched ball A hits ball B, resulting in a successful finish ("Agari") of ball B, the stroker gains the right to spark ball A, as long as the stroker's ball and ball A are stationary on the inner field.

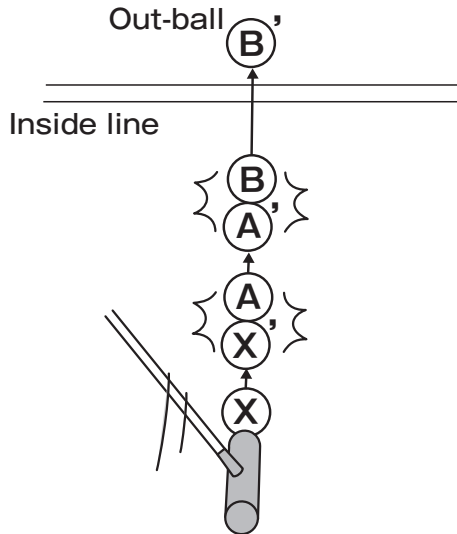

Reference

Article 15, Clause 2, Gaining the Right to Spark 1 of the Game Rules:

(Refer to the same rule outlined in Q105)

Q 107

After stroking the stroker's ball that was near the gate, the stick hits the gate and the stroker's ball ends up hitting ball B. However, as ball A is in contact with this gate, the stick hitting the gate resulted in ball A also moving. Is this a successful Touch, or is it a foul as ball A moved?

A

It is a successful Touch of ball B. Causing ball A to move is not a foul.

Explanation

1. As this results in a successful Touch of ball B, the stroker gains the right to stroke once more after achieving a successful spark.
2. As the movement of ball A is invalid, it is returned to the position it was in before it moved.

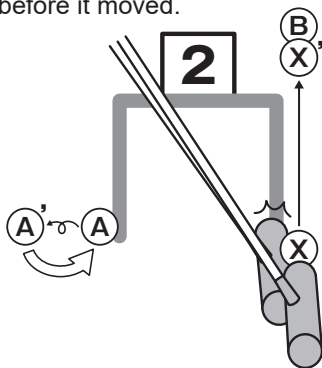

Reference

Article 11, Clause 2, Invalid Moves 1 (10) (iii) of the Game Rules:

"When a ball in contact with a gate or the goal-pole is moved indirectly as a result of the stick coming in contact with the gate or the goal-pole."

Article 15, Clause 2, Gaining the Right to Spark 1 of the Game Rules:

(Refer to the same rule outlined in Q105)

Q
108

A ball is sparked and stops in contact with the back side of the gate. The stroker's ball is stroked, causing it to hit the leg of the gate and make a successful pass through the gate. However, the stroker's ball comes into contact with the sparked ball and stopped. In this case, will the next stroke result in a "touching the same ball twice" foul?

A

A "touching the same ball twice" foul applies at the moment when the stroker's ball comes into contact with the sparked ball.

Explanation

The stroker's ball becomes an out-ball from the position it comes into contact with the sparked ball.

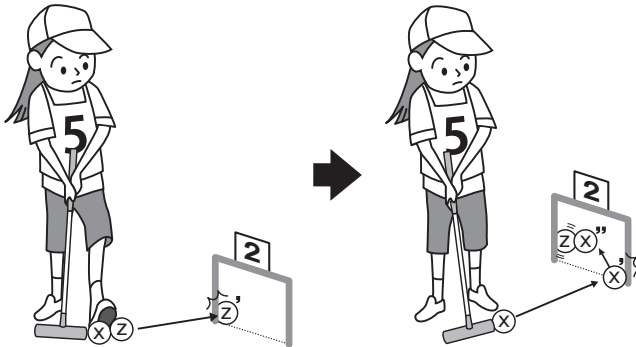

Reference

Article 15, Clause 4, Touching the Same Ball Twice 1 of the Game Rules:

"It is a "touching the same ball twice" foul if, during his/her continuous stroke, the stroker makes a Touch with a ball which he/she has already sparked."

Q 109

The stroker achieves a successful Pass Touch with ball B which was at the back side of the second gate. Ball B stops on the inner field, but the stroker's ball continues to roll, and then hits ball A which was sparked first. Has the stroker's ball made a successful pass through the second gate? And, can the stroker then spark ball B?

A

Although the Pass through the second gate of the stroker's ball is successful, the stroker may not spark ball B because the "touching the same ball twice" foul applies at the moment when the stroker's ball becomes in contact with ball A.

Explanation

1. Because the stroker's ball crosses completely through the gate line of the second gate to touch ball B as the result of a proper play by the stroker before the "touching the same ball twice" foul takes place, the pass through the second gate and the Touch by the stroker's ball with ball B are successful. However, the "touching the same ball twice" foul applies at the moment when the stroker's ball becomes in contact with the ball A, so the stroker may not spark ball B.
2. Ball A which moved as the result of the same ball being touched twice is returned to the position it was in before it moved, and the stroker's ball becomes an out-ball from where it was when the touching the same ball twice foul took place. As the movement of ball B is valid, it remains in the position it stopped in following the Touch.

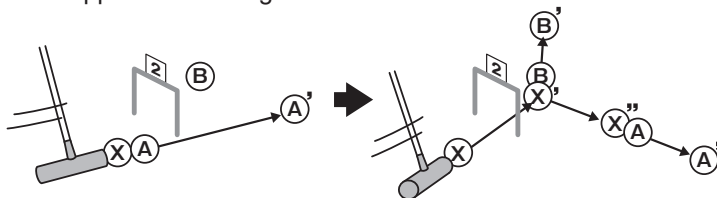

Reference

Article 15, Clause 4, Touching the Same Ball Twice 1 of the Game Rules:

(Refer to the same rule outlined in Q108)

Q
110

Does the stoker have to indicate the direction of the ball when attempting to make another ball an out-ball by sparking?

A

The stoker should indicate the direction of the ball to the referee when attempting to make another ball an out-ball.

Explanation

It is not a foul if the stoker does not indicate the direction of the ball to the referee, but when attempting to make another ball an out-ball by sparking, the stoker should indicate the direction of the ball as it is simply good manners and ensures the safety of the players.

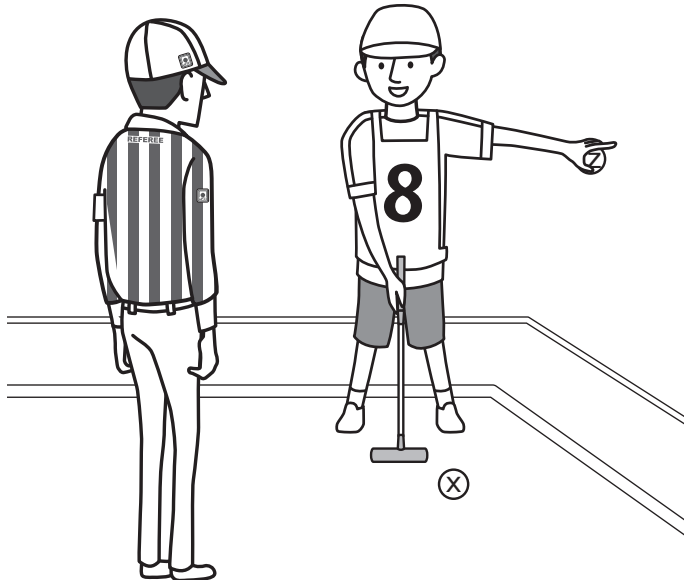

Q 111

When the stroker attempts to make touched ball A an out-ball during a Spark, sparked ball A hits ball B that has not been touched, resulting in ball B ending up in the outer field. At this point, sparked ball A stops so that the distance between the outer edge of ball A and the outer edge of the stroker's ball is less than 10 cm. Is ball B an out-ball? And, is ball B an out-ball if the distance between the outer edge of sparked ball A and the outer edge of the stroker's ball is 10 cm or more?

A

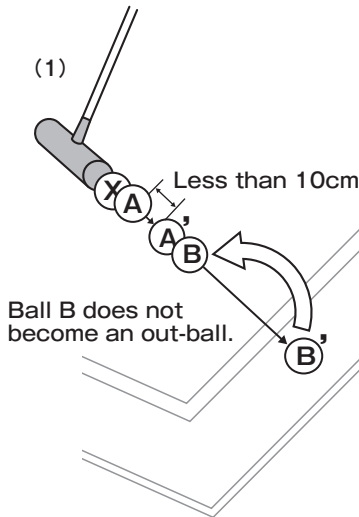

(1) Ball B does not become an out-ball if the distance between the outer edge of sparked ball A and the outer edge of the stroker's ball is less than 10 cm.

- (2) Ball B becomes an out-ball if the distance between the outer edge of sparked ball A and the stroker's ball is 10 cm or more.
- (3) If, during a Spark, sparked ball A hits ball B when the distance between the outer edge of ball A and the outer edge of the stroker's ball is less than 10 cm, and then ball A stops so that the distance between the outer edge of sparked ball A and the outer edge of the stroker's ball is 10 cm or more, in this case, ball B becomes an out-ball.

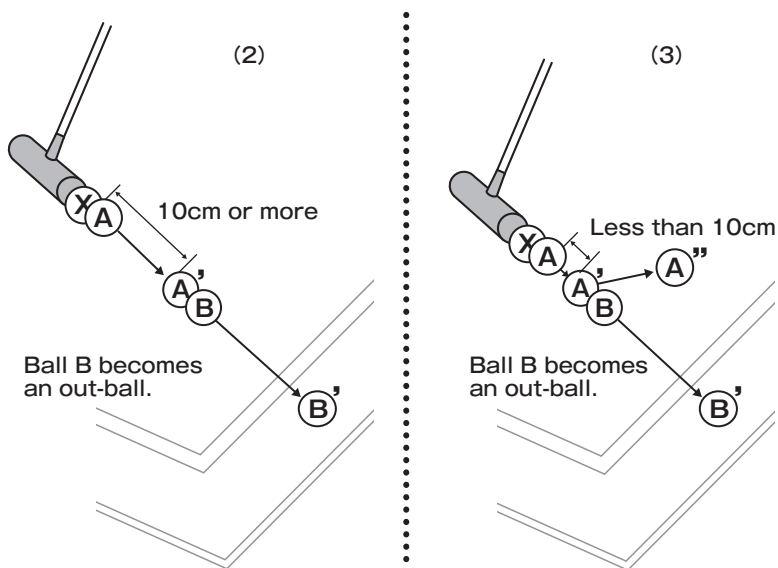

Explanation

1. If the distance between sparked ball A and the outer edge of the stoker's ball is less than 10 cm, the Spark of ball A is not successful, and instead is a sparking foul. Ball B is returned the position it was in before it moved, ball A is in the position that it was set in, and the stoker's ball becomes an out-ball from where it stopped after the Touch.
2. If the distance between sparked ball A and the outer edge of the stoker's ball is 10 cm or more, ball A is successfully sparked, and the stoker gains the right for continuous stroke, and therefore the stoker's ball can be stroked one more time.

Reference

Article 16, Clause 1, Spark 3 of the Game Rules:

"All movements made by the sparked ball are valid except for invalid moves."

Article 16, Clause 4, Sparking Foul 1 (5) of the Game Rules:

"If, following a Spark, the outer edge of the sparked other ball stops without moving at least 10 cm away from the outer edge of the stoker's ball, and the sparked other ball and the stoker's ball stop as in-balls."

Q 112

After a stroker achieves a Touch with ball A and ball B with a single stroke, ball A and ball B both stop on the inner field without being in contact with the stroker's ball. When ball A is sparked first, it hits ball B, and ball B then completely crosses over the gate line of the second gate. Does this represent a successful pass of the ball B through the second gate?

A

It is a successful pass of ball B through the second gate.

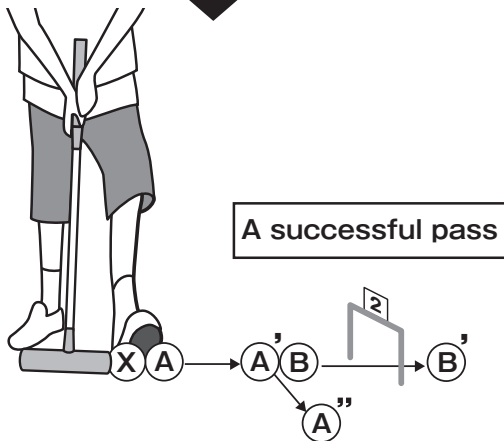
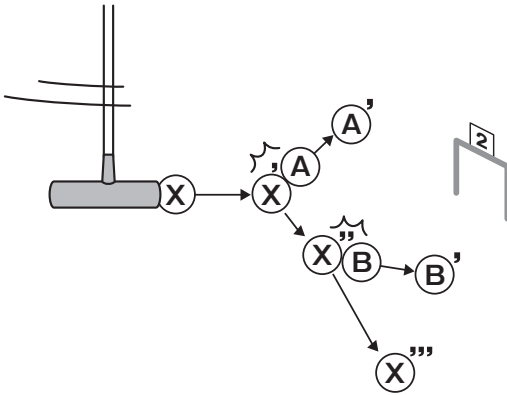

Explanation

1. Ball A remains in the position it was in following the Spark.
2. Although ball B can be sparked if it stops on the inner field, if it enters the outer field, it becomes an out-ball, and may not be sparked.
3. As the stroker's ball has successfully sparked ball A, regardless of whether ball B is sparked, the stroker can stroke one more time after all the actions on sparking are completed.

Reference**Article 12, Clause 3, Gaining the Right for Continuous Stroke 1 (2) of the Game Rules:**

"When a Spark is made successfully, the stroker can stroke his/her ball once more. The number of continuous strokes gained by making one or more successful Sparks is limited to one."

Article 16, Clause 1, Spark 3 of the Game Rules:

(Refer to the same rule outlined in Q111.)

**Q
113**

If the stroker's ball and the touched ball are adjacent (but not in contact), are the balls set by just stepping on the stroker's ball?

A

The balls are not set by just stepping on the stroker's ball unless the touched ball is in contact with the stroker's ball.

Explanation

1. If the stroker steps on his/her ball, then removes his/her foot from that ball, and picks up the touched ball, this does not represent a sparking foul.
2. If the stroker's ball is stepped on, the touched ball is set to be in contact with the stroker's ball, but there is a space between the stroker's ball and the touched ball, and if the space between the balls is small enough to carry out a Spark, the balls are deemed to be set.

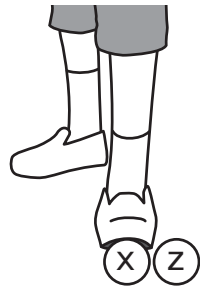

Q
114

If the stroker's ball and several touched balls are adjacent (but not in contact), does it mean that an action on sparking is carried out on several balls simultaneously at the point that the stroker steps on his/her ball?

A

As the balls are not set by just stepping on the stroker's ball, it will not be deemed as an action for sparking is carried out simultaneously for multiple balls at the point that the stroker steps on his/her ball.

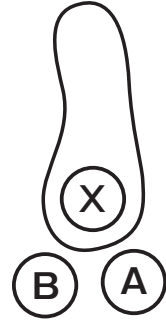

Q
115

The stroker's ball and the touched ball are adjacent (but not in contact), and the stroker comes into contact with the touched ball which is not in contact with the stroker's ball. Does this represent setting the two balls?

A

The balls are not set, as the touched ball and the stroker's ball aren't in contact with each other.

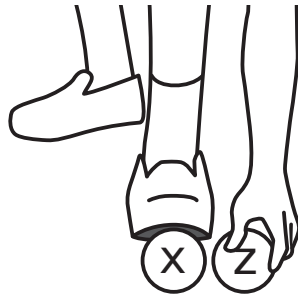

Explanation

In this situation, it is not a sparking foul if the foot is removed from the stroker's ball and the touched ball picked up.

Q 116

If the stroker's ball and the touched ball are adjacent (but not in contact), and the stroker only steps on his/her ball, can that stroker then carry out a Spark?

A

The stroker may not carry out a Spark. Doing so will be a stroking foul.

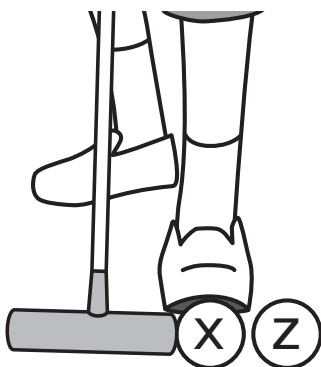

Explanation

When stepping onto the stroker's ball, as the balls aren't deemed to be set unless the touched ball and the stroker's ball are in contact with each other, the stroker may not spark.

Reference

Article 12, Clause 4, Stroking Foul 1 (11) of the Game Rules:
"When stroking the stroker's ball without sparking although the right to spark is gained."

Q 117

In what situation are the balls deemed to be set if there is a space between the balls but a Spark can still be carried out?

A

The following two situations apply to the above:

(1) If the stroker's ball and the touched ball are stepped on together.



(2) If only the stroker's ball is stepped on, and the touched ball is placed so that it is in contact with the stroker's ball, but after that, there is a space between the touched ball and the stroker's ball and the space is small enough to carry out a Spark.

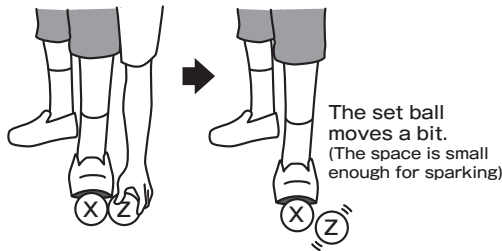

Reference

Article 16, Clause 1, Spark 2 (1) of the Game Rules:

"While setting the balls, even if the touched other ball is not in contact with the stroker's ball and there is a space between the two balls but it is still possible to carry out a valid Spark, it shall be deemed that the balls are set."

Article 16, Clause 1, Spark 2 (2) of the Game Rules:

"If the player steps on his/her ball and the touched other ball at the same time, the balls are set at the point that they were stepped on."

Q 118

Before stepping on the stroker's ball, the stroker places the touched ball in a position adjacent to (and not in contact with) the stroker's ball. The stroker then sets the balls by stepping on both the stroker's ball and the other ball. Does this represent a foul?

A

It is not a foul.

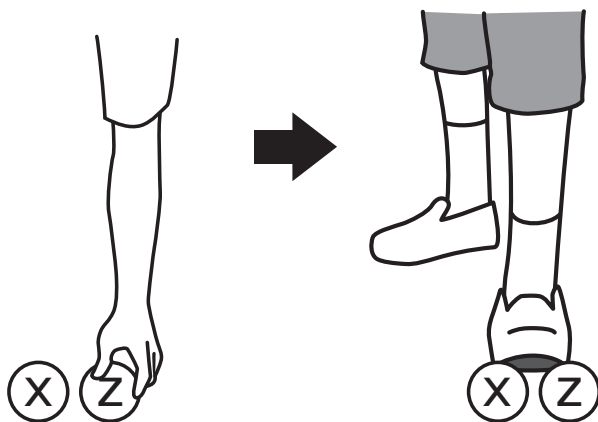

Explanation

As this is not a sparking foul in which the touched ball causes the stroker's ball or another ball to move, it is not a foul to place the touched ball, before stepping on the stroker's ball, so that it isn't in contact with the stroker's ball, but adjacent to it, and then the balls set by stepping on both balls.

Reference

Article 16, Clause 1, Spark 2 (1) of the Game Rules:

(Refer to the same rule outlined in Q117.)

Article 16, Clause 1, Spark 2 (2) of the Game Rules:

(Refer to the same rule outlined in Q117.)

Q 119

If the stroker's ball and the touched ball are in contact, is it a foul if the stroker comes into contact with the touched ball without stepping on his/her ball? And, is it a foul if the stroker comes in contact with the touched ball, causing the stroker's ball to move?

A

Neither situation represents a foul.

Explanation

In both situations, the movement of the stroker's ball is invalid, and therefore the ball is returned to the position it was in before it moved.

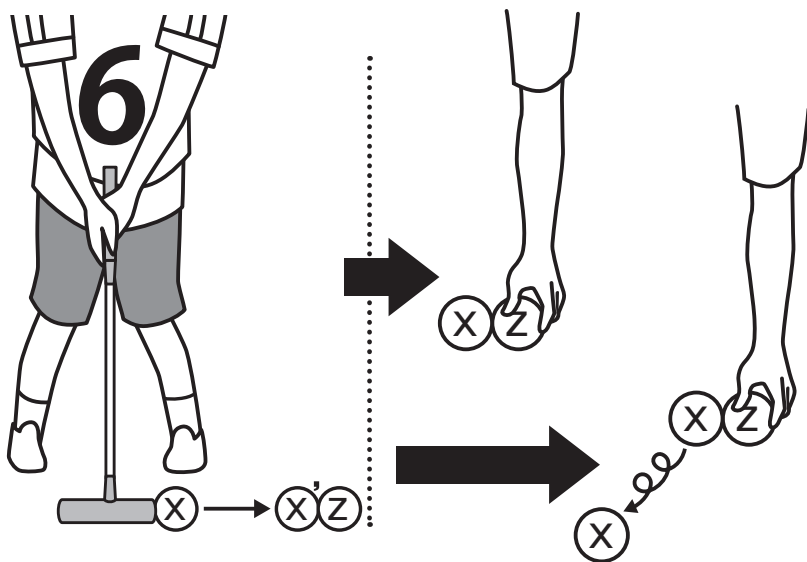

Reference

Article 11, Clause 2, Invalid Moves 1 (9) (i) of the Game Rules:

"When the stroker's ball stops in contact with another touched ball, and the stroker's ball moves as the result of the stroker picking up the touched ball as part of a stroker's action on sparring."

Q 120

A stroker gains the right to spark, after which the stroker steps on his/her ball that is on the edge of the inside line, resulting in the touched other ball to come into contact with the stroker's ball in the outer field. Is it a foul if, after this, the stroker removes his/her foot from the stroker's ball without picking up the other ball, and comes into contact with that ball?

A

Whether it is a foul or not depends on the situation.

(1) It is not a foul if:

1) the stroker's ball and other ball placed on the outer field aren't in contact when the foot is removed from the stroker's ball and the stroker comes into contact with the other ball.

(2) It is a foul if:

1) the stroker's ball and other ball placed on the outer field are in contact when the foot is removed from the stroker's ball and the stroker comes into contact with that ball while his/her ball and that ball are in contact.

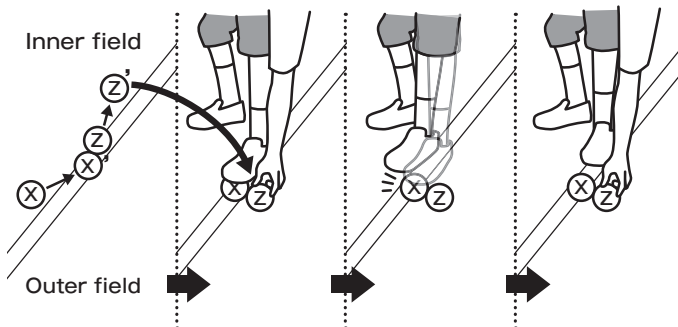

Explanation

1. If the touched ball is placed in the outer field, the balls are not deemed to be set even if the touched ball is placed so that it is in contact with the stroker's ball.
2. It is a sparking foul if the stroker's foot is removed from his/her ball without picking up the other ball, and the stroker comes into contact with that ball while his/her ball and that ball are in contact.

Reference

Article 16, Clause 1, Spark 2 of the Game Rules:

"Setting the balls refers to stepping on the stroker's own ball where the ball has stopped, and placing a touched ball inside the inner field so that it is in contact with the stroker's ball."

Article 16, Clause 4, Sparking Foul 1 (1) of the Game Rules:

"After picking up a touched ball, and before the Spark, the stroker's ball or another ball is directly moved by the touched ball."

Q
121

After a stroker gains the right to spark, the stroker's ball is positioned so that it is in contact with the touched ball, with the outer edge of that ball on the inside line. Are these balls deemed to be set?

A

The balls are deemed to be set.

Explanation

The balls are set if, when looking down at the balls, the stroker's ball and the other ball are in contact so that the outer edge of the touched ball is on the inside line.

- ①, ② and ③ are set.
- ④ is not set.

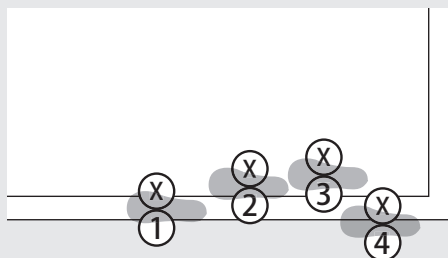

Reference

Article 16, Clause 1, Spark 2 of the Game Rules:

(Refer to the same rule outlined in Q120.)

Q
122

After a successful Spark, it is a foul to stroke one's ball while stepping on that ball. However, it is not a foul if the stick face continues to remain in contact with the ball under the foot from the time of the actual Spark to the time that the foot is removed from the ball. What is the difference between these two situations?

A

The difference is as follows:

- (1) The former refers to an action in which, following a successful Spark, the stroker's stick moves away from the stroker's ball, but comes in contact once again with the stroker's ball while the stroker is still stepping on his/her ball.
- (2) The latter refers to a part of an action on sparking in which the stick face continues to be in contact with the stroker's ball under the foot, from the time of the actual Spark to the time that the foot is removed from the ball.

Explanation

The act of stroking, following a successful Spark, while stepping on the stroker's ball, is a stroking foul, and therefore the stroker's ball becomes an out-ball.

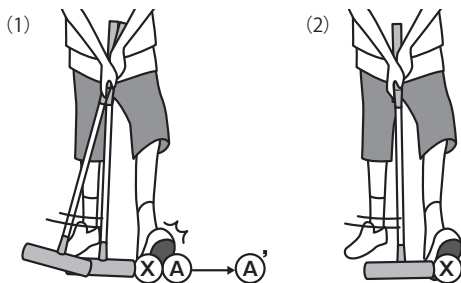

Reference**Article 12, Clause 4, Stroking Foul 1 (12) of the Game Rules:**

"Following a successful Spark, when stroking the stroker's ball before all the stroker's actions on sparking are completed."

Article 16, Clause 2, Stroker's Actions on Sparking 1 of the Game Rules:

"Stroker's actions on sparking refers to all actions after the point at which all the balls inside the inner field come to a stop following a successful Touch, to the point when the stroker steps off his/her own ball following a successful Spark. The stroker's actions on sparking are as follows:"

Q
123

Is it a foul if, after a successful Touch, the stroker's ball and the touched ball stop on the inner field without being in contact, and before picking up the touched ball, the stroker steps only on his/her ball, then removes his/her foot, picks up the touched ball, and then steps on that ball once again?

A

It is not a foul.

Explanation

It is neither a foul nor a set if only the stroker's ball is stepped on without the touched ball being picked up.

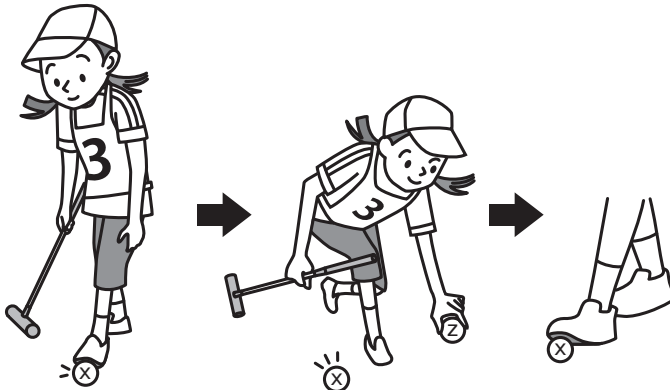

Q 124

After a stroker achieves a Touch with ball A and ball B in a single stroke, ball A and ball B stop on the inner field without being in contact with the stroker's ball. The stroker first successfully sparks ball A, and as ball B is close by, the stroker then picks up ball B to set it up without removing his/her foot from his/her ball. Is this a foul?

A

It is not a foul.



Reference

Article 16, Clause 2, Stroker's Actions on Sparking 2 (1) of the Game Rules:

"Picking up another ball that was touched after stepping on one's own ball."

Q

125

During the actions on sparking, the stroker picks up his/her ball thinking that it was the touched ball. Is this a ball touch foul?

A

It is a ball touch foul.



Explanation

1. The touched ball remains where it stopped following the Touch, and the stroker's ball becomes an out-ball from the position where it was in before it moved (where it stopped following the Touch).
2. During the actions on sparking, it is a proper play when the stroker steps on his/her ball, and when the stroker's hand comes into contact with his/her ball when setting the balls. Picking up the stroker's ball is, however, not a proper play.

Reference

Article 18, Clause 1, Ball Touch Foul 2 (4) of the Game Rules:

"If a ball touch foul occurs during the stroker's actions on sparking, the process outlined in Article 16, Clause 4, Sparking Foul 2 on sparking foul shall be followed, depending on the situation at the time."

Q
126

After a stroker achieves a successful Touch with a ball, he/she puts his foot on this ball thinking it is his/her ball. Is this a foul?

A

It is not a foul.

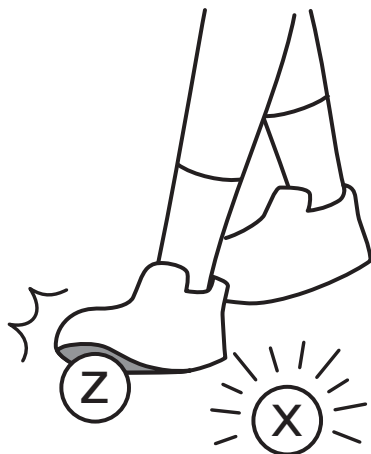

Explanation

1. As the stroker is permitted to be in contact with the touched ball during his/her actions on sparking, it is not a foul if the foot comes into contact with the ball. However, it is not appropriate behavior for a stroker to draw a ball over using the foot. A touched ball should always be picked up with the hand.
2. It is a ball touch foul if the stick comes into contact with the touched ball.

Reference

Article 12, Clause 4, Stroking Foul 1 (9) of the Game Rules:
"If the stick comes into contact with another stationary ball."

Q 127

A stroker picks up a touched ball and is walking away, when the stroker drops that ball which ends up hitting the stick. Is this a foul?

A

It is not a foul.



Explanation

The following situations represent a stroking foul.



(1) If a stick dropped by the stroker comes into contact with a ball.

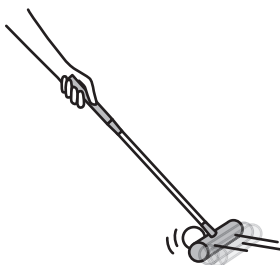

(2) If the stick comes into contact with the touched, stationary ball.

Reference

Article 12, Clause 4, Stroking Foul 1 (9) of the Game Rules:
(Refer to the same rule outlined in Q126.)

Q 128

After a successful Touch, the stroker's ball and the touched ball then come into contact with the gate leg and stop. Can the stroker pick up the touched ball?

A The stroker can pick up the ball.

Explanation

As it is an invalid move if the stroker's ball in contact with the gate leg moves before the touched ball is picked up, the stroker's ball is returned to the position it was in before it moved.

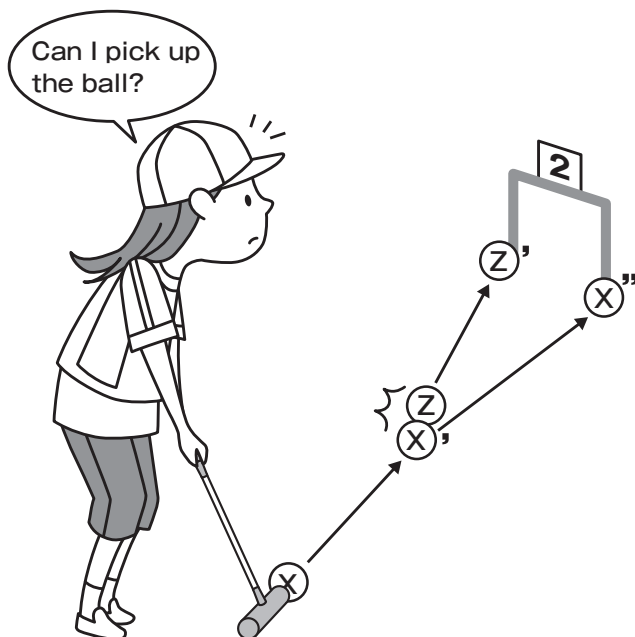

Reference

Article 11, Clause 2, Invalid Moves 1 (9) (v) of the Game Rules:
"When the stroker's ball and a touched other ball stop in contact with a gate or the goal-pole and, during an action on sparking, the stroker picks up the touched other ball to indirectly move his/her ball."

Q

129

During the actions on sparking, the stroker holds the touched ball, and attempts to set his/her ball by stepping on it. The stroker, however, drops the touched ball, which then comes into contact with the stroker's ball under the foot. Is this a sparking foul?

A

It is not a sparking foul.

Explanation

A touched ball coming into contact with the stroker's ball under the foot is a part of the actions on sparking, and therefore the stroker can then set the touched ball and spark.

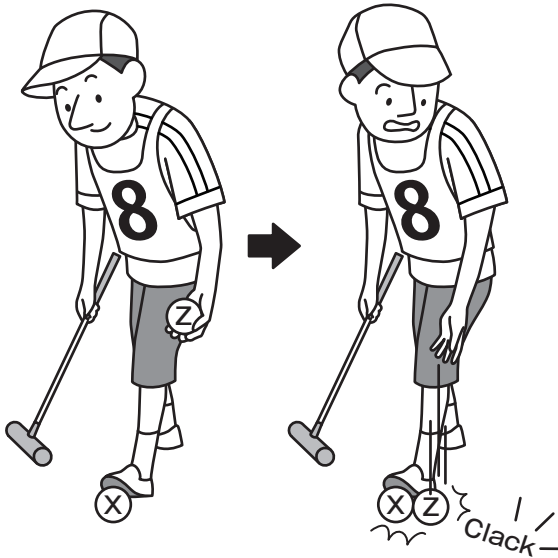

Reference

Article 16, Clause 1, Spark 2 of the Game Rules:

"Setting the balls refers to stepping on the stroker's own ball where the ball has stopped, and placing a touched ball inside the inner field so that it is in contact with the stroker's ball."

Q
130

During the actions on sparking, the stroker is holding the touched ball and steps on his/her ball, when that ball moves under the foot. The stroker then uses his/her hand, which is holding the other ball, to return the stroker's ball under the foot to the position it was in before it moved. Is this a ball touch foul?

A

It is not a foul.

Explanation

The hand coming into contact with the stroker's ball or the stroker's ball moving under the foot while setting the balls represents a proper play, and therefore the stroker can set up the touched ball and spark.

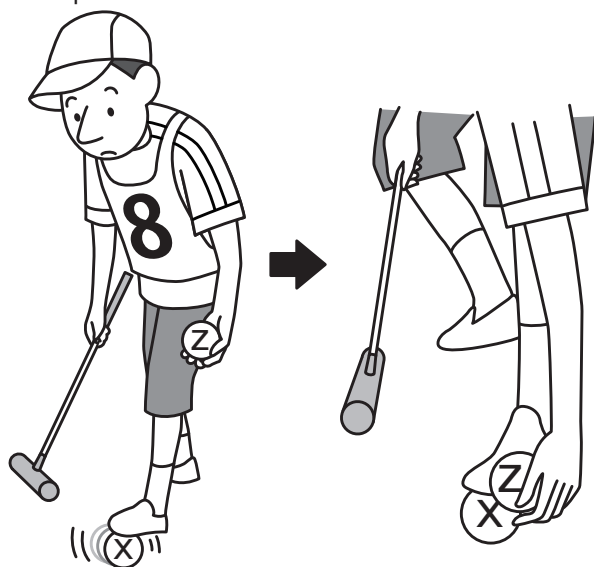

Reference

Article 16, Clause 2, Stroker's Actions on Sparking 2 (3) of the Game Rules:

"Touching one's own ball while setting."

Article 16, Clause 2, Stroker's Actions on Sparking 2 (6) of the Game Rules:

"The stroker's ball moves underneath his/her foot."

Q 131

After a successful Touch with ball A and ball B, both ball A and ball B stop and are in contact with the stroker's ball at the front side of the second gate. The stroker then temporarily moves ball B, and first sparks ball A. Ball A hits ball B which was temporarily moved, and ball B then completely crosses over the gate line of the second gate. Does this represent a successful pass of ball B (which has successfully passed through the first gate) through the second gate?

A

It is not a successful pass of ball B through the second gate.

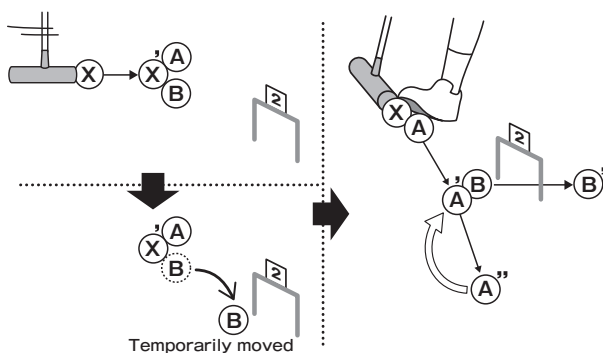

Explanation

1. If the sparked ball hits the temporarily moved ball, the subsequent movement of any balls is invalid, and therefore the balls are returned to the positions they were in before the sparked ball hit that temporarily moved ball. As a result, this does not represent a successful pass of ball B through the second gate.
2. After the referee returns ball A to where it hit ball B, the stroker can spark ball B.
3. In order to avoid this situation, the stroker should not move the ball to a position that will obstruct the game, while the referee should adjust the position of the ball as soon as he/she determines that the ball that was temporarily moved by the stroker could obstruct the game.

Reference

Article 11, Clause 2, Invalid Moves 1 (8) of the Game Rules:

"The movement of a ball as a result of a sparked other ball hitting another ball that was temporarily moved by the stroker."

Q

132

Is it a sparking foul if, during the actions on sparking, the stroker is re-setting the balls and temporarily removes the foot from his/her ball and then steps on the ball once again?

A

It is not a foul.

Explanation

When resetting the balls, it is not a foul even if the stroker temporarily removes the foot from his/her ball and then steps on the ball again. Also it is not a foul to pick up the set ball when the stroker is not stepping on the stroker's ball.

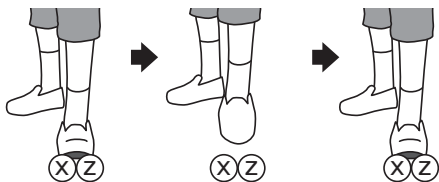

Reference

Article 11, Clause 2, Invalid Moves 1 (9) (vii) of the Game Rules:

"If, when resetting the balls, the stroker's ball is moved as a result of the stroker picking up the set other ball while he/she is not stepping on his/her ball."

Article 16, Clause 2, Stroker's Actions on Sparking 2 (2) of the Game Rules:

"Replacing or twisting one's own foot while having stepped on one's own ball."

Article 16, Clause 2, Stroker's Actions on Sparking 2 (4) of the Game Rules:

"Resetting the ball."

Article **16** **Spark**

Clause **3** **Completions of Sparking**

Q
133

After a Spark, the distance between the outer edge of the sparked ball and the outer edge of the stroker's ball is 10 cm or more. The sparked ball then hits the gate and bounces back and stops on the inner field. The distance between the outer edge of the sparked ball and the outer edge of the stroker's ball is 5 cm. Does this represent a successful Spark?

A

It is a successful Spark.

Explanation

It is a successful Spark as the distance between the outer edge of the sparked ball and the outer edge of the stroker's ball is initially 10 cm or more.

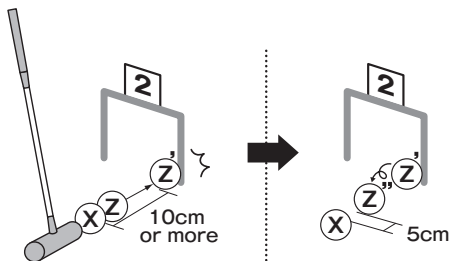

Reference

Article 16, Clause 3, Completions of Sparking 1 (1) of the Game Rules:

"When the outer edge of the other sparked ball is 10 cm or more away from the outer edge of the stroker's ball."

Article 16, Clause 4, Sparking Foul 1 (5) of the Game Rules:

"If, following a Spark, the outer edge of the sparked other ball stops without moving at least 10 cm away from the outer edge of the stroker's ball, and the sparked other ball and the stroker's ball stop as in-balls."

Q
134

According to the Game Rules, it is a sparking foul if, after picking up a touched ball, and before the Spark, the stroker's ball or another ball is directly moved by the touched ball. What type of situation would this apply to?

A

The following situations will apply:

1. If the stroker drops the ball from his/her hand, causing the stroker's ball or another ball to move.
2. If, before stepping on his/her own ball, the ball in the stroker's hand comes into contact with the stroker's ball.

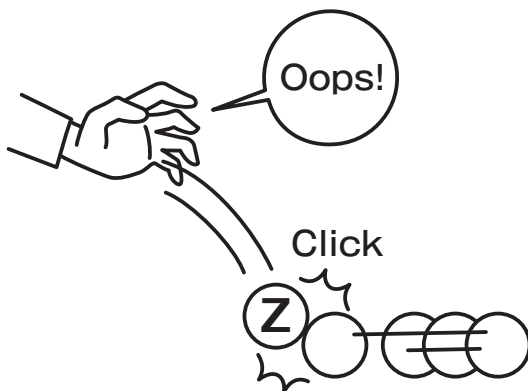

Reference

Article 16, Clause 4, Sparking Foul 1 (1) of the Game Rules:
"After picking up a touched ball, and before the Spark, the stroker's ball or another ball is directly moved by the touched ball."

Q

135

After a stroker achieves a Touch with ball A and ball B with a single stroke, both ball A and ball B stop on the inner field in contact with the stroker's ball. Then, while the stroker is temporarily moving ball B which is to be sparked after ball A, he/she drops ball B, directly causing the stroker's ball or another ball to move. Would this result in referee time?

A

No, this would not result in referee time.

Explanation

1. If the stroker picks up a touched ball, and then this ball directly causes the stroker's ball or another ball move before a Spark is carried out, this would be a sparking foul.
2. Similarly, it is a sparking foul if the stroker's ball or another ball is moved by a ball that is being temporarily moved.
3. Referee time refers to the time required for the referee to temporarily move a ball.
4. The temporary move of the ball by the stroker is not something that is carried out by the referee, and therefore referee time does not apply.

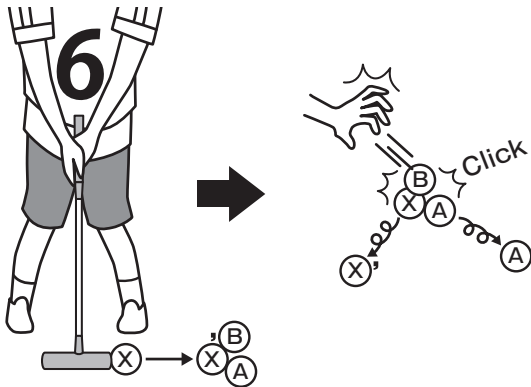

Reference

Article 16, Clause 4, Sparking Foul 1 (1) of the Game Rules:
(Refer to the same rule outlined in Q 134.)

Q 136

Is it a proper Spark if, during the actions on sparking, the hand is removed from the set ball at the same time as the Spark is carried out?

A It is not a proper Spark.

Explanation

1. It is a sparking foul if the referee determines that the action of removing the hand from the set ball and the Spark were carried out simultaneously.
2. The set ball remains in the position it was set in, and the stroker's ball becomes an out-ball from where it stopped after the Touch.

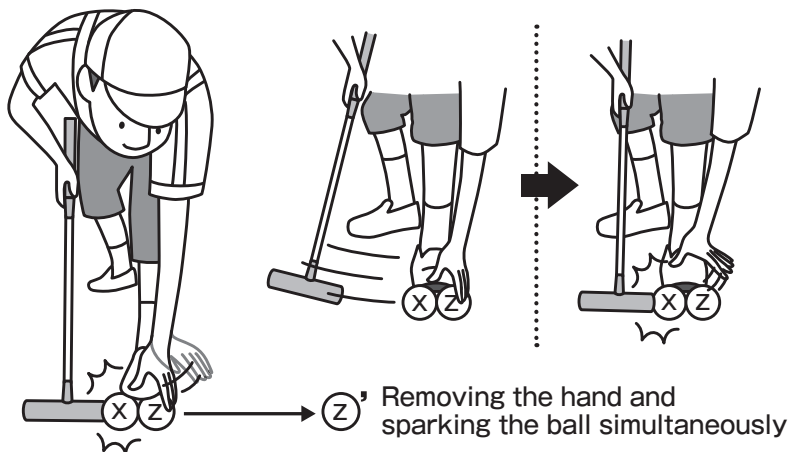

Reference

Article 16, Clause 4, Sparking Foul 1 (3) of the Game Rules:

"If the stroker hits his/her ball without moving the hand from the set other ball."

Q 137

Is it a foul if, during the actions on sparking, the stroker steps on the stroker's ball and the foot comes into contact with the touched ball?

A

This could be a foul depending on the situation.

(1) It is not a foul if:

- 1) Following a successful Touch with a ball, the stroker steps on his/her ball and the foot comes into contact with the touched ball.
- 2) Following a successful Touch with several balls, the stroker steps on his/her ball before picking up a touched ball, and the foot comes into contact with one of the touched balls near his/her ball.

(2) It is a foul if:

- 1) Following a successful Touch with several balls, the touched balls stop without coming into contact with the stroker's ball, and the stroker steps on his/her ball before picking up the touched ball, and the foot comes into contact with the multiple touched balls.
 - a. The touched ball is returned to the position it stopped in following the Touch.
 - b. The stroker's ball becomes an out-ball from where it stopped following the Touch.
- 2) Following a successful Touch with several balls, the touched balls stop without coming into contact with the stroker's ball, and the stroker picks up one of the touched balls, and steps on his/her ball to set that ball then his/her foot comes into contact with the other touched ball.

- a. The touched ball is returned to the position it stopped in following the Touch.
- b. The stroker's ball becomes an out-ball from where it stopped following the Touch.

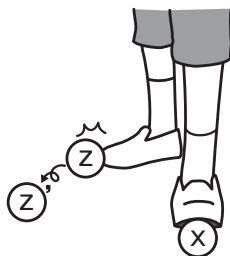

Reference

Article 16, Clause 4, Sparking Foul 1 (8) of the Game Rules:

"If the stroker comes into contact with several touched other balls simultaneously, other than when the stroker's ball stops in contact with 3 or more touched other balls, and the balls to be sparked after the first touched ball are temporarily moved."

Q

138

When setting the touched ball during the actions on sparking, is it a foul if the stroker steps on his/her ball after the touched ball is placed so that it is in contact with the stroker's ball?

A

It is a sparking foul.



Always set the other ball after first stepping on and securing your own ball!!

Explanation

1. The touched ball is returned to the position it stopped in following the Touch. The stroker's ball becomes an out-ball from where it stopped following the Touch.
2. When setting the ball, the stroker should first step on his/her ball when it is stationary, then place the touched ball in contact with his/her ball on the inner field.

Reference

Article 16, Clause 4, Sparking Foul 1 (1) of the Game Rules:

(Refer to the same rule outlined in Q134.)

Q
139

After the stroker sparks the touched ball, the ball moves so that the distance between the outer edge of that ball and the outer edge of the stroker's ball is 10 cm or more. The sparked ball then hits the gate and bounces back, hits the stroker's ball, and stops so that is in contact with the stroker's ball. What should the referee do in this situation?

A

The sparked ball remains in the position it stopped in contact with the stroker's ball, and the stroker's ball becomes an out-ball from where it stopped, in contact with the other ball, following the Spark.

Explanation

It is not a foul if, after the ball is sparked, the distance between the outer edge of that ball and the outer edge of the stroker's ball is at least 10 cm, and the sparked ball hits the gate and bounces back and stops, without being in contact with the stroker's ball.

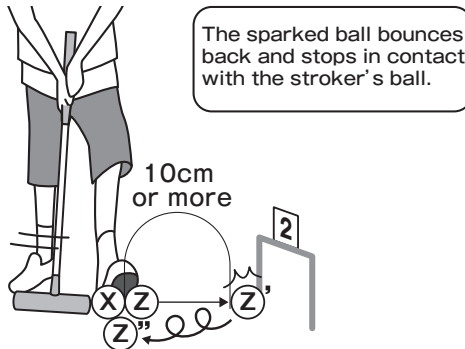

Reference

Article 16, Clause 4, Sparking Foul 1 (6) of the Game Rules:
 "Following a successful Spark, if the other sparked ball hits a gate or the goal-pole and returns to stop in contact with the stroker's ball as an in-ball."

Q 140

After a Touch with ball A and ball B is achieved with a single stroke, the stroker first successfully sparks ball A, and then goes on to spark ball B, when ball B hits ball A, causing ball A to move to hit the stroker's ball and stop. Although ball B has been successfully sparked, does this represent a sparking foul?

A This is a sparking foul.

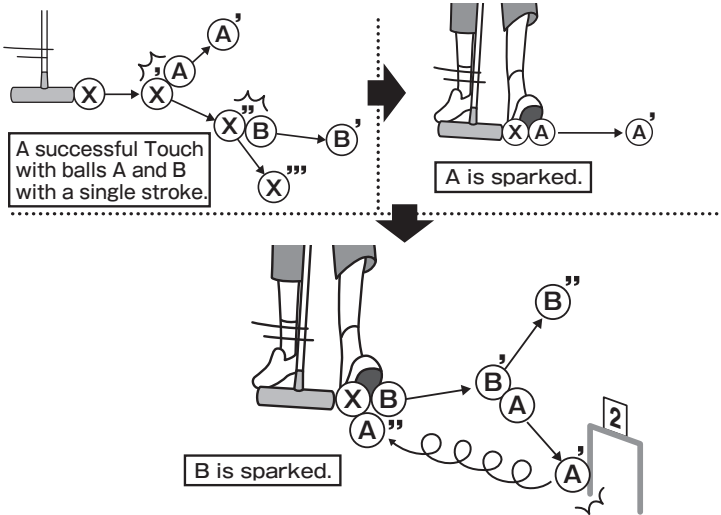

Explanation

1. Regardless of whether the ball that was sparked is the first or second ball, it is a sparking foul if the sparked ball and the stroker's ball come in contact with each other.
2. Following the Spark, ball B remains in the position it stopped in, ball A remains in the position it stopped in, in contact with the stroker's ball, and the stroker's ball becomes an out-ball from where it stopped after coming into contact with the ball A.

Reference

Article 16, Clause 4, Sparking Foul 1 (6) of the Game Rules:
(Refer to the same rule outlined in Q139.)

Q
141

After successfully sparked ball A hits ball B that has not been touched, ball B bounces back and stops in contact with the stroker's ball from which the stroker has removed his/her foot. Ball A has been successfully sparked, but is the Touch with ball B successful?

A

This would depend on whether, after this move, there are no balls other than ball A that have to be sparked, or whether there is ball C which has to be sparked.

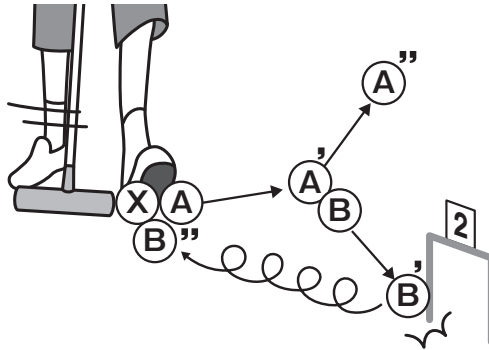

- (1) If there are no balls other than ball A that have to be sparked:
 - 1) It would result in the stroker's continuous stroke and a successful Touch with ball B that came into contact with the stroker's ball and stopped.

- (2) If ball C still needs to be sparked:
- 1) If ball C still needs to be sparked, this may result in a ball touch foul or time over foul.
 - a. If the stroker's ball is stepped on in order to spark the ball C, this would result in ball B – which came into contact with the stroker's ball and then stopped in contact with the stroker's ball – moving, and therefore would be a ball touch foul. If nothing is done in order to avoid a ball touch foul, then this would be a time over foul.
 - b. In both cases, ball B is returned to where it stopped in contact with the stroker's ball, and ball C is returned to the position it stopped in following the Touch. The stroker's ball becomes an out-ball from where it stopped following the Touch.

Explanation

If sparked ball A hits ball B which hasn't been touched, and ball B bounces back to come into contact with the stroker's ball under the foot and then stops, ball B would move as a result of removing the foot from the stroker's ball, and therefore this would result in a ball touch foul, and is dealt with as follows:

Ball B remains where it came into contact with the stroker's ball and stopped. The stroker's ball becomes an out-ball from where it stopped following the Touch. Ball C, which needed to be sparked, is returned to the position it stopped in following the Touch.

Reference**Article 9, Clause 2, Time Over 2 (iii) of the Game Rules:**

"If a time-over foul takes place during a stroker's action on sparking, Article 16, Clause 4, 'Sparking Foul' 2 shall apply, depending on the situation at the time."

Article 18, Clause 1, Ball Touch Foul 2 (4) of the Game Rules:

"If a ball touch foul occurs during the stroker's actions on sparking, the process outlined in Article 16, Clause 4, 'Sparking Foul 2' on sparking foul shall be followed, depending on the situation at the time."

Q

142

After a successful Touch with ball A and ball B with a single stroke, the stroker's ball, ball A and ball B stop on the inner field without being in contact with each other. After this, the stroker is walking, holding ball A, as part of the actions on sparking, when he/she steps on ball B. What foul does this represent?

A

It is a sparking foul.

Explanation

Touched ball A and ball B are returned to the positions they stopped in following the Touch. The stroker's ball becomes an out-ball from where it stopped following the Touch.



Reference

Article 16, Clause 4, Sparking Foul 1 (8) of the Game Rules:
(Refer to the same rule outlined in Q137.)

Q 143

Is it a sparking foul if, during a Spark, the stroker strokes his/her ball with a part of the stick other than the face?

A

It is not a sparking foul but a stroking foul during the actions on sparking. The set ball remains in the position it was set in, and the stroker's ball becomes an out-ball from where it stopped after the Touch.



Stroking one's ball with any part of the stick other than the face.

Reference

Article 12, Clause 4, Stroking Foul 2 (5) of the Game Rules:

"If a stroking foul takes place during a stroker's action on sparking, Article 16, Clause 4, 'Sparking Foul 2' shall apply, depending on the situation at the time."

Q 144

When resetting a ball, is it still a sparking foul if the foot is removed from the stroker's ball without picking up the other ball?

A It is not a foul.

Explanation

1. Resetting the balls represents proper play. So it is not a foul simply to remove the foot from the stroker's ball, as the balls are set by stepping on the stroker's ball once again. The balls can also be reset by stepping on the stroker's ball again and then picking up the other ball.
2. If the other ball is picked up without re-stepping on one's own ball after the foot is removed from the set stroker's ball, this would not represent a sparking foul. However, it is not appropriate behavior. The stroker should step on his/her ball first, and then pick up the other ball.

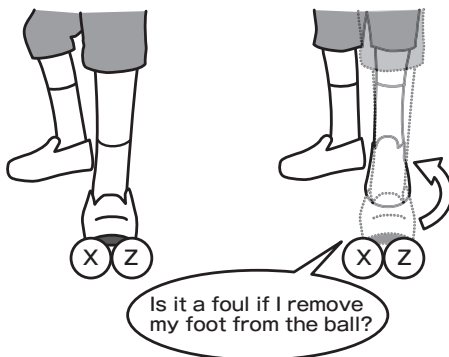

Reference

Article 11, Clause 2, Invalid Moves 1 (9) (vii) of the Game Rules:

"If, when resetting the balls, the stroker's ball is moved as a result of the stroker picking up the set other ball while he/she is not stepping on his/her ball."

Article 16, Clause 2, Stroker's Actions on Sparking 2 (4) of the Game Rules:

"Resetting the ball"

Q
145

After a ball has been set for sparking, the stroker picks up that ball in order to change the direction of the Spark and is altering his/her stance when the foot moves away from the stroker's ball. Although the stroker's ball stopped where it stopped following the Touch, would this still be a sparking foul?

A

It is not a foul.

Explanation

This is proper play as the foot hasn't missed the stroker's ball, and the balls can therefore be reset.

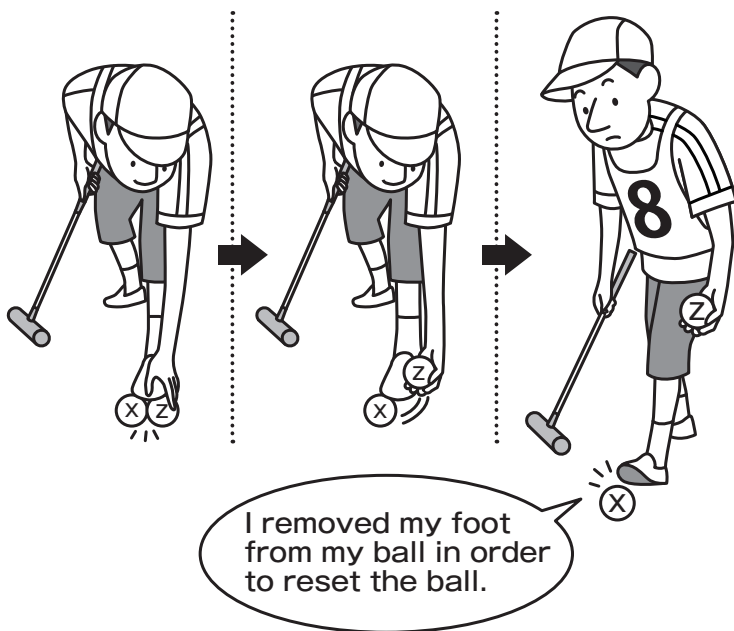

Reference

Article 16, Clause 2, Stroker's Actions on Sparking 2 (4) of the Game Rules:

(Refer to the same rule outlined in Q144.)

Q 146

Is it a sparking foul if, during the actions on sparking, the stroker's ball rolls away from under the foot?

A It is a sparking foul.

Explanation

If the stroker's ball rolls away from under the foot while the stroker is stepping on that ball, the following shall apply, depending on the situation:

(1) If the stroker's ball rolls away from under the foot before the touched ball is set, the touched ball is returned to the position it stopped in following the Touch. The stroker's ball becomes an out-ball from where it stopped following the Touch.



(2) After the balls are set, if the stroker's ball rolls away from under the foot before a successful Spark, the other ball remains in the position it was in when set, and the stroker's ball becomes an out-ball from where it stopped following the Touch.

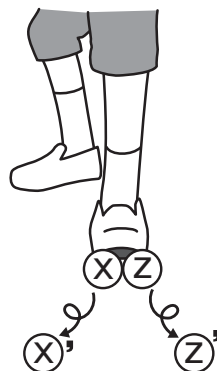

(3) If, after a successful Spark, the stroker's ball rolls away from under the foot before the foot is removed from the ball, the other ball remains in the position it stopped in following the Spark, and the stroker's ball becomes an out-ball from where it stopped following the Touch.

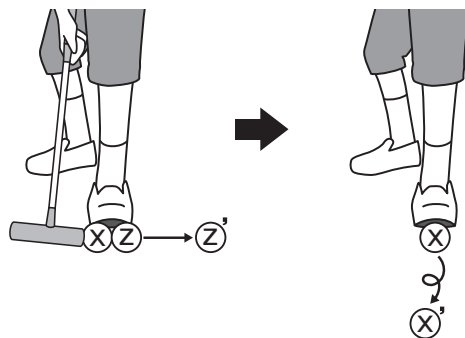

Reference

Article 16, Clause 4, Sparking Foul 1 (2) of the Game Rules:

"If the stroker's ball moves away from under the stroker's foot."

Q 147

After a successful Spark and while the sparked ball is moving across the inner field, the stroker's ball rolls away from the stroker's foot. Is this a sparking foul?

A

It is a sparking foul.

Explanation

The sparked ball remains in the position it stopped in after moving, and the stroker's ball becomes an out-ball from where it stopped following the Touch.

Reference

Article 16, Clause 4, Sparking Foul 1 (2) of the Game Rules:

(Refer to the same rule outlined in Q146.)

Q 148

After a successful Touch of ball A and ball B with a single stroke, ball A and ball B stop in contact with the stroker's ball on the inner field. In order to spark ball A, the stroker temporarily moves ball B and places it less than 10 cm from his/her ball and then sparks ball A. Ball A then hits temporarily moved ball B, and completely crosses over the gate line of the second gate. Although ball A has successfully passed through the first gate, does this also represent a successful pass through the second gate?

A This does not represent a successful pass of ball A through the second gate.

Explanation

1. When sparked ball A hits the temporarily moved ball B, all the balls that move as a result are invalid moves, and therefore are returned to the positions they were in before moving. Sparked ball A is therefore returned to where it came into contact with temporarily moved ball B.
2. As the distance between the outer edge of the stroker's ball and the outer edge of the touched ball B is less than 10 cm, sparked ball A is returned to where it came into contact with temporarily moved ball B, and therefore this does not represent a successful Spark of ball A but a sparking foul.
3. Ball B is returned to the position it was in before it was temporarily moved (where it stopped following the Touch), ball A is

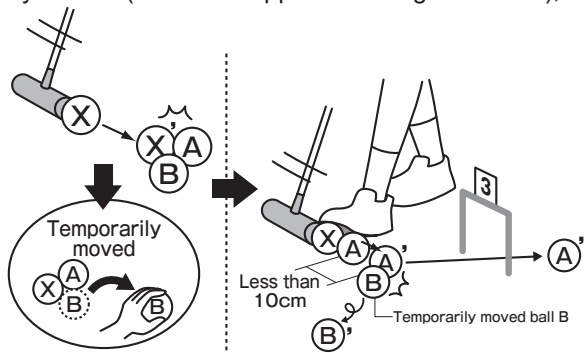

- returned to the position it was set in, and the stroker's ball becomes an out-ball from where it stopped following the Touch.
4. In order to prevent the above from taking place, the stroker should ensure that the ball is not temporarily moved to a position that may obstruct the game, while the referee, if he/she determines that the position of the ball that has been temporarily moved by the stroker could obstruct the game, should immediately reposition that ball.

Reference

Article 11, Clause 2, Invalid Moves 1 (8) of the Game Rules:

"The movement of a ball as a result of a sparked other ball hitting another ball that was temporarily moved by the stroker."

Article 16, Clause 4, Sparking Foul 1 (5) of the Game Rules:

"If, following a Spark, the outer edge of the sparked other ball stops without moving at least 10 cm away from the outer edge of the stroker's ball, and the sparked other ball and the stroker's ball stop as in-balls."

Q
149

After a successful Touch with ball A and ball B with a single stroke, ball A and ball B stop in contact with the stroker's ball on the inner field. In order to spark ball A, the stroker temporarily moves ball B. After this, during the actions on sparking ball A, the stroker comes into contact with ball B. Is this a foul? Would the situation be dealt with differently depending on the type of contact (e.g. the foot, the stick, clothing including the uniform, the stroking order number or glasses coming into contact with the ball, or the stroker coming into contact with the ball when adjusting the position of the temporarily moved ball)?

A

Regardless of how the stroker comes into contact with the ball, it is not a foul if the stroker comes into contact with a ball that has been temporarily moved during the Spark.

Explanation

1. As ball B has been temporarily moved and can be repositioned by the stroker or the referee if it is going to obstruct the game, the stroker can go on to spark after that stroker or the referee adjusts the position of ball B.
2. In order to prevent the above from happening, the stroker should ensure that the ball is not temporarily moved to a position that may obstruct the game, while the referee, if he/she determines that the position of the ball that has been temporarily moved by the stroker could obstruct the game, should immediately reposition that ball.

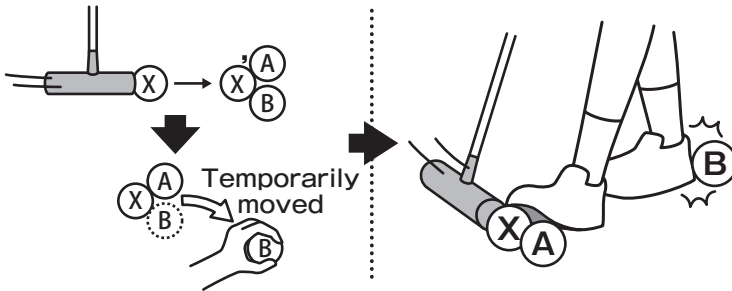

Q
150

After a successful Touch with ball A and ball B with a single stroke, ball A and ball B stop in contact with the stroker's ball on the inner field. The stroker then picks up ball B to move it temporarily in order to spark ball A, when he/she steps on ball A. Is this a foul?

A

This is a sparking foul.

Explanation

1. Although the stroker picks up ball B to move it temporarily, because he/she has stepped on ball A while temporarily moving ball B, this means that he/she has come into contact, simultaneously, with multiple touched balls.
2. Touched balls A and B are placed in the position they stopped in following the Touch, and the stroker's ball becomes an out-ball from where it stopped following the Touch.
3. The temporary move ends when the hand, used to place the ball to be temporarily moved, is removed from the ball.
4. After ball B has been temporarily moved, it is not a sparking foul if the stroker comes into contact with ball B when sparking ball A.



Reference

Article 16, Clause 4, Sparking Foul 1 (8) of the Game Rules:
(Refer to the same rule outlined in Q137.)

Q

151

After a successful Touch with ball A and ball B with a single stroke, ball A and ball B stop in contact with the stroker's ball on the inner field. The stroker then picks up ball B, but before sparking ball A, returns the ball B to the position it was in before it moved (where it stopped following the Touch), and picks up ball A. If it isn't a foul to come into contact with a ball that has been temporarily moved during the actions on sparking, can the stroker then carry out the Spark?

A

The stroker may not carry out the Spark.

Explanation

1. This is a sparking foul.
2. It is not a foul to come into contact with a ball that has been temporarily moved during the actions on sparking. If, however, after temporarily moving ball B, ball B is once again returned to the position it was in before it was moved (where it stopped following the Touch) before sparking ball A, and then ball A is temporarily moved, this would be seen as changing the sparking order.
3. If this takes places before ball A is set, ball A and ball B are returned to the positions they stopped in following the Touch,

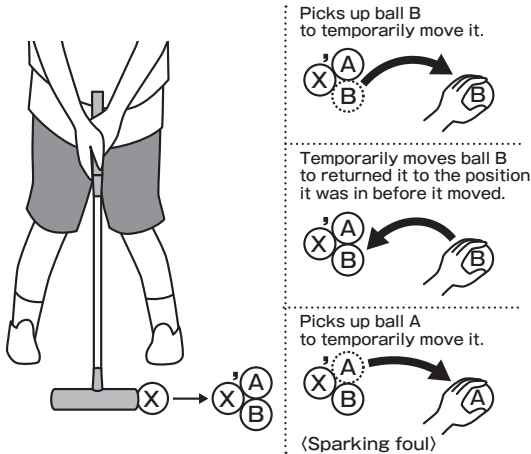

and the stroker's ball becomes an out-ball from where it stopped following the Touch. If this takes place after ball A is set, ball B is returned to the position it stopped in following the Touch, ball A is returned to the position it was in when it was set, and the stroker's ball becomes an out-ball from where it stopped following the Touch.

Reference

Article 16, Clause 4, Sparking Foul 1 (7) of the Game Rules:
"If, after touching several balls and picking up the first touched other ball, the order of the Spark is changed."

Q
152

Is it a foul if the stroker uses his/her foot to draw the touched ball over?

A

As the stroker is allowed to come into contact with a touched ball in order to carry out a Spark, it is not a foul even if the foot is used to draw the ball over.

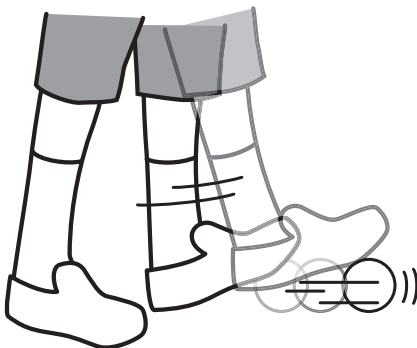

Explanation

It is not a foul. However, it is not an appropriate behavior for a stroker to draw a ball over using the foot. A touched ball should always be picked up with the hand.

Q
153

After a successful Touch, the touched ball (that has made a successful pass through the first gate) and the stroker's ball both move from the front side of the second gate and stop on the gate line in contact with each other. If the foul takes place before the balls are set, and the other ball is moved to the back side of the gate with the play by the next stroker, so that it completely crosses over the gate line, does this represent a successful pass through the second gate? And, if the foul takes place after the stroker's ball and the other ball are stepped on together and set, does this represent a successful pass through the second gate if the other ball is moved to the back side of the gate with the play by the next stroker so that it completely crosses over the gate line?

A

1. It is a successful pass of the other ball through the second gate that was placed where it stopped in following the Touch, as the result of a foul before the balls were set.
2. It is not a successful pass of the other ball through the second gate that was placed in the position where it was when it was set, as the result of a foul after the balls were set.

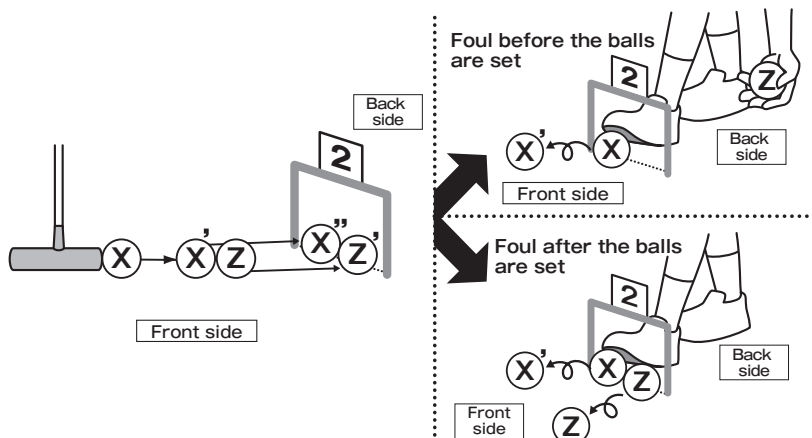

Explanation

In both cases, the stoker's ball becomes an out-ball from where it stopped following the Touch.

Reference

Article 13, Clause 1, Successful Pass Through a Gate 1 (2) (iii) of the Game Rules:

"A ball which has been a set other ball in a Spark and which is placed in a position where its outer edge is on the gate line as the result of a sparking foul which has occurred after setting the balls but before making a successful Spark."

Q
154

After gently stroking the stroker's ball 1 which is an out-ball so that it stops on the inside line, the outer edge of the ball is slightly on top of the outer edge of the inside line when looking down at the balls. Is the stroker's ball an in-ball?

A

It is an in-ball.

Explanation

It is an in-ball as long as the outer edge of the stroker's ball is on the inside line when viewed from above.

① ② and ③ are in-balls.

④ is an out-ball.

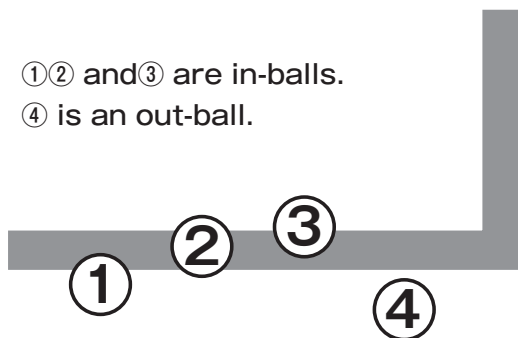

Q
155

The stroker's stick face comes into contact with his/her ball that is an out-ball, but the stroker's ball doesn't move. What should the referee do in this situation?

A

The referee shall announce "Number XX, out-ball" at the point that he/she determines that the stroker's stick face has come into contact with the stroker's ball and that the stroker's ball will not go inside the inner field, and then make the ball an out-ball.

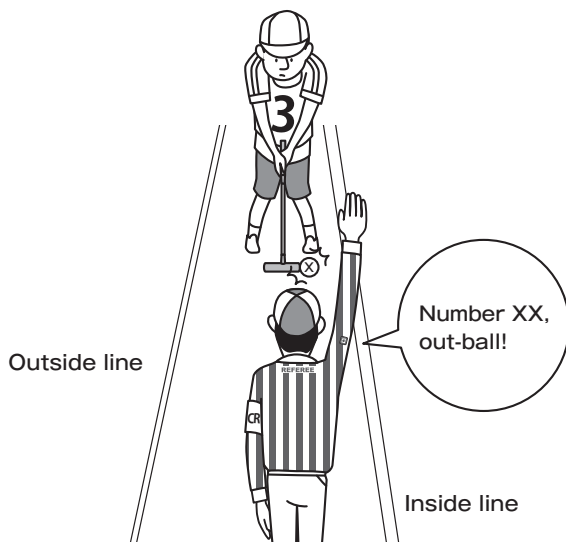
**Reference**

Article 17, Clause 2, Out-ball 1 (1) (iv) of the Game Rules:

"A ball which does not go into the inner field by stroking an out-ball."

Q

156

An out-ball is stroked and moves along the inside line, and after first entering the inner field, depending on the condition of the field, crosses over the inside line and enters the outer field to stop on the inner field. Is this an in-ball?

A

It is not an in-ball.

Explanation

1. The stroked out-ball becomes an out-ball at the point that it re-enters the outer field from the inner field.
2. It becomes an out-ball from where it entered the outer field after crossing over the inside line.

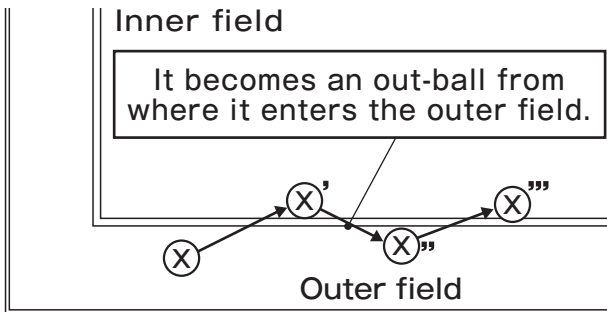

Reference

Article 17, Clause 2, Out-balls 1 (1) (iii) of the Game Rules:

"A ball which goes to the outer field again as a result of stroking an out-ball."

Article 17, Clause 2, Out-balls 2 (1) (i) of the Game Rules:

"In the case of 1. (1) (i), (ii) or (iii) of this clause, the ball shall be placed at the point created by drawing a vertical line from the point where the ball passed the inside line towards the outer field, with the outer edge of the stoker's ball 10 cm away from the inside line."

Q
157

If a stroked out-ball hits the gate with which another ball is in contact, resulting in the ball that is in contact with the gate indirectly moving, how does the referee deal with that ball and the stroker's ball? If the stroker's ball stops where the other ball was before it moved, how does the referee deal with that ball and the stroker's ball?

A

1. The other ball is returned to the position it was in before it moved, as the move is invalid. The stroker's ball remains where it stopped, as the move is valid.
2. If the stroker's ball stops where the other ball was before it moved, this is an out-ball stroking foul, and the other ball is returned to the position it was in before it moved as it made an invalid move, and the stroker's ball becomes an out-ball from where the foul took place (where it becomes in contact with the other ball that has been returned to the position it was in before it moved).

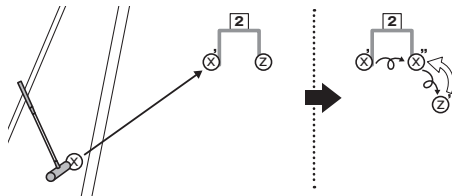
**Reference****Article 11, Clause 2, Invalid Moves 1 (4) of the Game Rules:**

"The movement of a ball in contact with a gate or the goal-pole as a result of stroking an out-ball."

Article **18** **Ball Touch Foul**

Clause **1** **Ball Touch Foul**

Q 158 A stroker entering the inner field comes into contact with another ball that is an out-ball. Is this a foul?

A It is a ball touch foul.

Explanation

1. The ball involved in the ball touch foul is returned to the position it was in when the stroker came into contact with that ball.
2. The player becomes a stroker the moment he/she is called to stroke. As the stroker's action is an effective play, if the stroker carries out a move that is a foul, then the appropriate foul is applied.

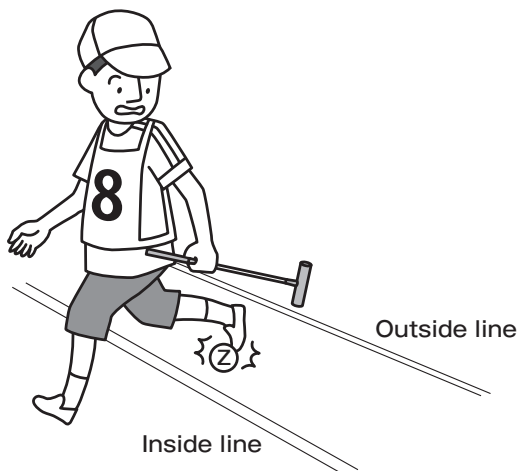

Reference

Article 18 Clause 1, Ball Touch Foul 2 (1) of the Game Rules:
"If a stroker comes into contact with a stationary ball."

Q 159

A ball sparked by the stroker hits the gate, bounces back, and comes into contact with the stroker's foot. What foul would this be? How does the referee deal with this situation?

A

1. It is a ball touch foul.
2. The ball corresponding to the ball touch foul is returned to the position it was in when the stroker came into contact with that ball, and the stroker's ball becomes an out-ball from where it stopped (in this case where it stopped following the Touch).



Reference

Article 18 Clause 1, Ball Touch Foul 2 (2) of the Game Rules:

"If the stroker touches a ball other than his/her ball while it was moving."

Q
160

Is it a ball touch foul if, after a stroker picks up a touched ball, he/she drops the touched ball and it falls onto the foot?

A

It is not a foul.

Explanation

1. As the stroker is allowed to come into contact with the ball as part of the actions on sparking, it is not a foul even if the touched ball is dropped and comes into contact with the foot as long as the stroker's ball or another ball doesn't move directly as the result of the touched ball.
2. It is a stroking foul if a stick dropped by the stroker comes into contact with the ball, or when the stick comes into contact with the touched ball.



Reference

Article 12 Clause 4, Stroking Foul 1 (9) of the Game Rules:
"If the stick comes into contact with another stationary ball."

Q 161

Is it a ball touch foul if a player order number falls off and comes into contact with the ball, the string of a player order number worn by a player comes into contact with the ball, or if a stroker's glasses fall and come into contact with the ball?

A

None of the above is a ball touch foul.

Explanation

1. Although players mustn't wear anything that could hinder the game, glasses are excluded as players with poor eyesight need glasses in order to play. It is therefore not a ball touch foul if a player's glasses come into contact with the ball.
2. As any movement by the ball as a result of coming into contact with the player order number or glasses is an invalid move, the ball is returned to the position it was in before it moved.



Reference

Article 11 Clause 2, Invalid Moves 1 (10) (iv) of the Game Rules:

"When the uniform, number or any of a stroker's belongings (including glove, cap, hat, glasses and the captain's identification) touches a ball."

Q

162

After a successful Spark, the sparked ball hits the gate and bounces back to hit the stroker's ball under the foot to stop in a position that is less than 10 cm between the outer edge of the stroker's ball under the stroker's foot and the outer edge of the sparked ball. Although the sparked ball did not hit the stroker's foot, is this still a ball touch foul?

A

It is not a foul.

Explanation

1. Although it is a ball touch foul if a sparked ball hits the foot that is on the stroker's ball, in this case it only hits the stroker's ball under the foot and therefore is not a foul.
2. As any movement of the sparked ball after hitting the stroker's ball under the foot is also a valid move, the sparked ball remains in the position it stopped in following the Spark, and the stroker may stroke his/her ball one more time.
3. The referee has power to determine whether the sparked ball hit only the stroker's ball under the foot, or whether it also hit the foot. In other words, the referee has power to determine whether it is a foul or not. This decision must therefore be made with care.

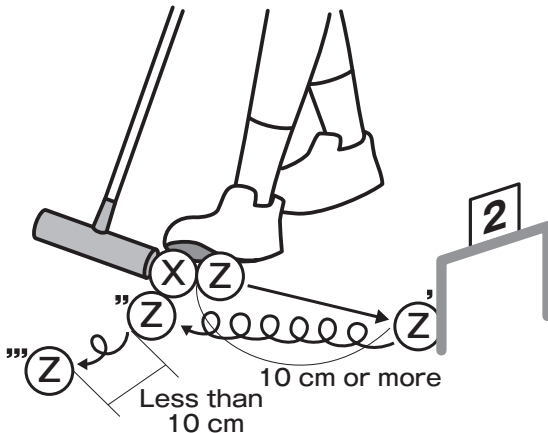

Q 163

During the actions on sparking, the stroker holds touched ball A and steps on his/her ball. The ball moves from under the foot and comes into contact with ball B that hasn't been touched and which is near the stroker's ball. Is the movement of the stroker's ball and ball B an invalid move?

A

It is not an invalid move. It is a ball touch foul that takes place during the actions on sparking.

Explanation

1. It is proper play if the stroker's ball under the foot moves, but it is a foul if the stroker's ball comes into contact with ball B.
2. Touched ball A is returned to the position it stopped in following the Touch, ball B is returned to its position before it moved, and the stroker's ball that moved under the foot becomes an out-ball from where it stopped following the Touch.

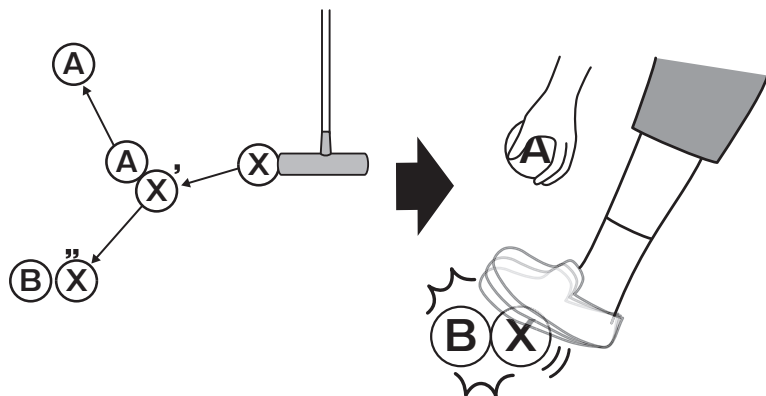

Reference

Article 18 Clause 1, Ball Touch Foul 2 (4) of the Game Rules:

"If a ball touch foul occurs during the stroker's actions on sparking, the process outlined in Article 16, Clause 4, 'Sparking Foul 2' on sparking foul shall be followed, depending on the situation at the time."

Q 164

After a successful Touch with ball A, the stroker gains the right to spark. Before setting up the balls, however, the stroker's foot comes into contact with ball B, resulting in a ball touch foul that takes place during the actions on sparking. How should the referee deal with this situation?

A

1. Ball B is returned to the position it was in before it moved.
2. Touched ball A is returned to the position it stopped in following the Touch.
3. The stroker's ball becomes an out-ball from where it stopped following the Touch.

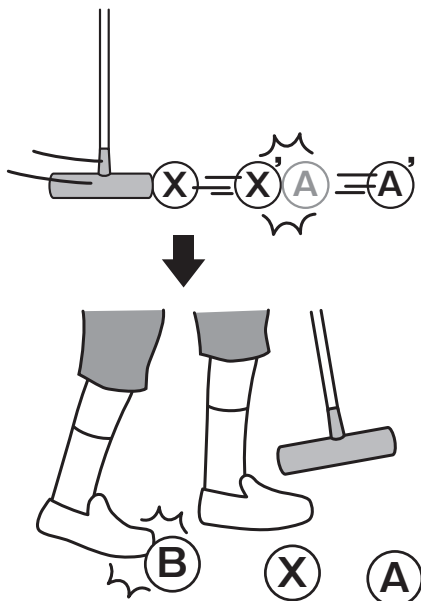

Reference

Article 18 Clause 1, Ball Touch Foul 2 (4) of the Game Rules:
(Refer to the same rule outlined in Q163.)

Q 165

After a successful Touch with ball A and ball B with a single stroke, followed by a successful Spark of ball A, ball B is picked up while ball A is still moving across the inner field. How does the referee address this situation?

A

1. Ball B remains in the position it stopped in following the Touch. The stroker's ball becomes an out-ball from where it stopped following the Touch.

Explanation

1. The right for continuous stroke is generated after all the balls on the inner field stop moving. As the stroker picked up ball B before the right for continuous stroke is generated, this is a ball touch foul.
2. As ball A has been successfully sparked, it remains in the position it stopped in following the Spark.

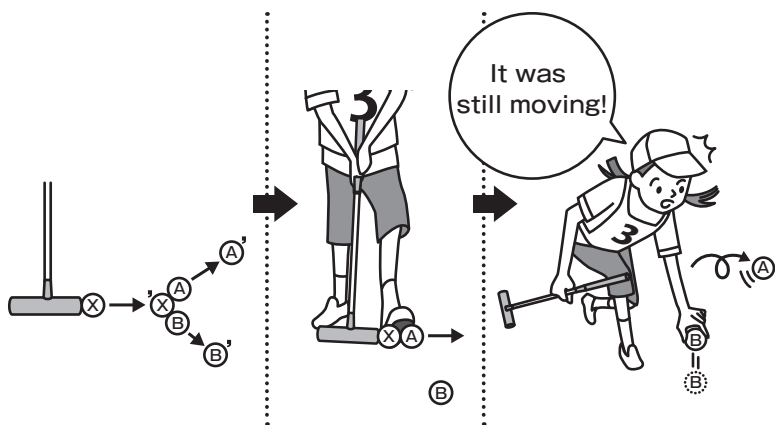

Reference

Article 18 Clause 1, Ball Touch Foul 2 (4) of the Game Rules:
(Refer to the same rule outlined in Q163.)

Article **19** **Play Interference**

Clause **1** **Play Interference**

Q
166

If a player is ejected from the game, can that player be substituted, rather than being recorded as an absent number?

A

It is not possible to substitute a player who has been ejected from the game.

Reference

Article 19 Clause 1, Play Interference 2 (4) (i) of the Game Rules:

"The ball of a player who has been ejected will be removed from the court."

Article 19 Clause 1, Play Interference 2 (4) (ii) of the Game Rules:

"The number of the player who has been ejected will be an absent number."

Article 19 Clause 1, Play Interference 2 (4) (iii) of the Game Rules:

"Points of the player who has been ejected obtained prior to the ejection shall be valid."

Q
167

Where should a player ejected from the game go?

A

A player who has been ejected may not remain on the court or in the free zone during that game. That player must leave the ground.

Q

168

What exactly is an act aimed at delaying the match?

A

Although the decision is up to the referee and depends on the situation, the following are some examples:

- (1) A stroker intentionally and repeatedly changing the sparking direction.
- (2) Intentionally and forcefully stroking the ball in a direction where there is no one to stop the ball, making it an out-ball.
- (3) Deliberately carrying out a foul.
- (4) Intentionally carrying out an invalid move.
- (5) Intentionally carrying out an ineffective play.
- (6) Intentionally asking the referee irrelevant questions.

Explanation

Any action aiming to delay the match is inappropriate and should never be carried out.

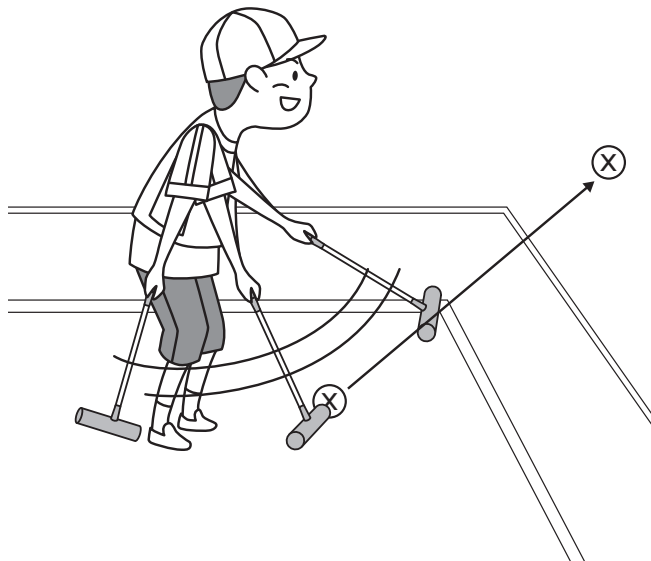

Q

169

What should the referee do when a team is delaying the match?

A

1. If the manager or a player does not comply with the essential rules governing the manager and player as prescribed in Article 4, Clause 4 of the Game Rules by, for example, one team delaying the match, the referee shall first caution that team to prevent the play interference.
2. If the Chief Referee or Assistant Referee determines that the manager or player's actions are clearly aimed at delaying the match and therefore interfering with the game, the Chief Referee shall apply the play interference rule.
3. If the Chief Referee or Assistant Referee determines, near the end of the game, that the game is being interfered with, the Chief Referee calls the next stroker to stroke, in order to maintain the rights of the next stroker, after which the referee applies the play interference rule.

Explanation

1. Referee time applies to the time during which the play interference rule is being applied.
2. Any action aimed at delaying the match is inappropriate and should never be carried out.

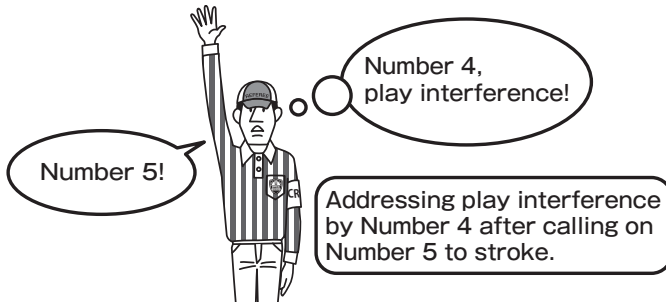

Reference

Article 20 Clause 1, Referee Time 2 of the Game Rules:

"Referee time is not included in the 10 second count, but included in the game time."

Q 170

Stroker Number 5 sparks Ball Number 7, and it looks as though it will be an out-ball, but Player Number 7 then uses his/her stick to stop that ball so that it remains on the inner field. As this is a move by someone other than the stroker, is it an invalid move, and does Ball Number 7 remain where it stopped on the inner field?

A

1. This is not deemed an invalid move. If the manager or player/s of a team directly interferes with the game, as Player Number 7 has done in this situation, the Chief Referee can immediately apply the play interference rule in order to prevent the team that was involved in the play interference from having an advantage over the other team.
2. Ball Number 7 becomes an out-ball from where it is assumed the ball would have entered the outer field if Player Number 7 had not interfered with the game.

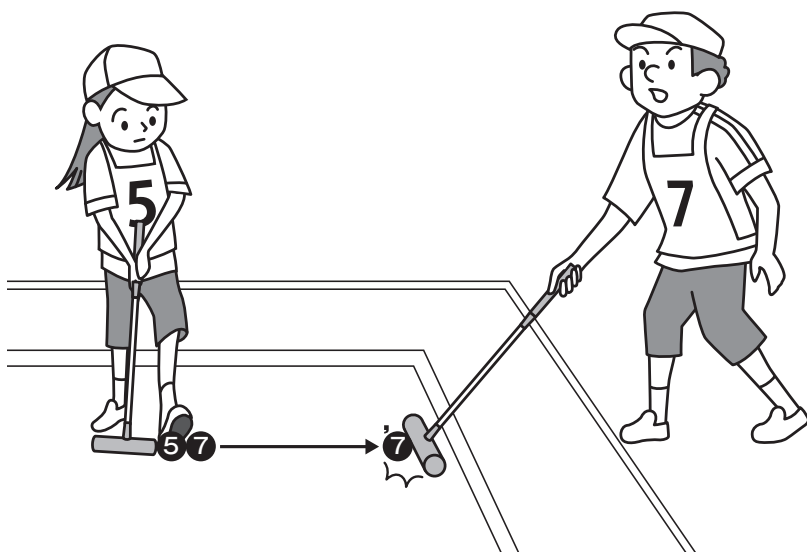

Explanation

1. If the Chief Referee or Assistant Referee determines that the manager or player/s has interfered with the game, Chief Referee can carry out the following, depending on the situation:
 - (1) Take away the rights to stroke.
 - (2) Make relevant ball(s) an out-ball.
 - (3) Disallow successful passes through gates and finishes ("Agari").
 - (4) Eject a manager or player from the game.
 - (5) Declare the team disqualified.
2. What should be considered in this situation is the fact that although it is Player Number 5 who is carrying out the stroke, it is Player Number 7 who has interfered with the game. The Chief Referee takes this into consideration to deal appropriately with the player who has interfered with the game and his/her team.
3. Players should never carry out any actions, such as those described above, that may interfere with the game.

Reference**Article 10 Clause 2, Ineffective Plays 1 (2) of the Game Rules:**

"Actions of a person other than the stroker."

Article 11 Clause 2, Invalid Moves 1 (2) of the Game Rules:

"The movement of a ball following an ineffective play."

Article 19 Clause 1, Play Interference 1 (2) of the Game Rules:

"When the referee determines that a manager or player is interfering with the game."

Article 19 Clause 1, Play Interference 2 of the Game Rules:

"When play interference occurs, the following steps will be taken, depending on the situation at the time, to ensure the interference does not benefit the team which has committed the play interference:

- (1) Take away the rights as a stroker from the stroker.
- (2) Relevant ball(s) becomes an out-ball.
- (3) Disallow successful passes through gates and finishes.
- (4) Eject a manager or player from the game.
- (5) Declare the team disqualified."

Q 171

The referee cautions a manager or player, other than the stroker, who is on the outer field, but a player of that team ignores the referee. Can the Chief Referee apply the game interference penalty?

A

The Chief Referee can apply the play interference penalty.

Explanation

It is absolutely inappropriate behavior for a manager or members of a team other than the stroker to enter the court.



Reference

Article 9 Clause 1, Play and Rights as a Stroker 4 of the Game Rules:

"When the rights as a stroker end, the stroker shall promptly exit the court."

Article 19 Clause 1, Play Interference 1 of the Game Rules:

(Refer to the same rule outlined in Q170.)

Q
172

During referee time, a stroker mistakenly carries out a move that corresponds to a foul. In this case, does the stroker lose the right to stroke?

A

The stroker does not lose his/her right to stroke.

Explanation

1. As the stroker's move during referee time represents ineffective play, the move itself is not recognized and therefore is not a foul.
2. The referee shall issue the stroker with a caution.

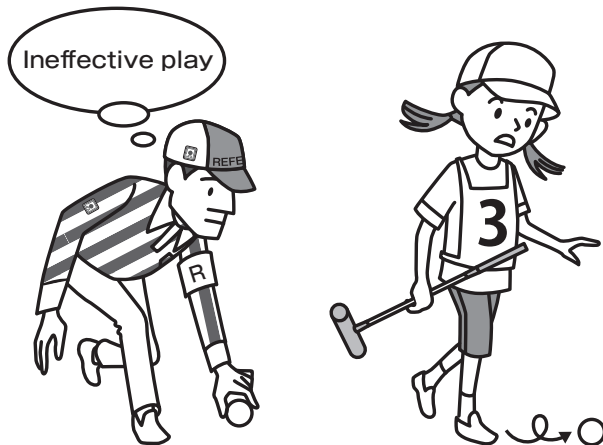
**Reference**

Article 10 Clause 2, Ineffective Plays 1 (1) of the Game Rules:
"Plays made by a stroker during referee time."

Q
173

A player has the right for continuous stroke when it becomes referee time, during which the referee signals that the game is over. Can that stroker play after the end of referee time?

A

That stroker can continue to play until his/her right to play ends.

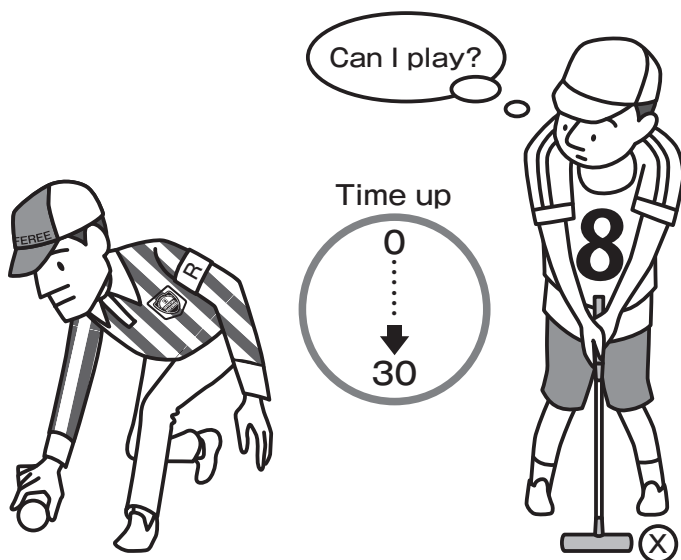

Q
174

Is the time from the announcement of a decision on a foul, to the next stroker being called to play referee time?

A

Regardless of whether there has been a foul or not, the time from the stroker ending his/her right as a stroker to the next stroker being called to play is deemed referee time.

Q
175

Is the time taken for a referee to confirm and respond to a question by a manager or captain the referee time?

A

Yes, it is referee time.



Q
176

Can the sticks be exchanged during the game and used for different purposes, as long as the multiple sticks have been inspected during the inspection of equipment and clothing?

A

The sticks can be exchanged and used as long as this is indicated to the referee.

Reference

Article 21, Clause 1, Exchanging the Stick 1 (1) of the Game Rules:

"A stroker may only bring one stick into the field."

Article 21, Clause 1, Exchanging the Stick 1 (2) of the Game Rules:

"The sticks that can be exchanged are limited to sticks that have already been inspected before starting the game."

Q
177

A stroker's stick breaks while the stroker is playing. What happens if the stroker doesn't have a spare stick that has been inspected before the start of the game?

A

The player can borrow, from a member of his/her team, a stick that has been inspected before the start of the game.

Explanation

The time required to exchange the stick is not referee time.

Article **22****Interruption of the Game**Clause **1****Interruption of the Game****Q**
178

The game is interrupted 20 minutes after the start of the game, resulting in a called game. How are the winning and losing teams determined if the score at this point of the game is a tie?

A

1. The winner of the game is determined by the details of the points achieved by each team.
2. If the winner is not able to be determined by the details of the points achieved by the two teams, the game shall end in a tie.

Explanation

1. If there is somewhere that a tie-breaker can be carried out, the winner can be decided through a tie-breaker.
2. Even if a game is interrupted due to an emergency while the leading team is playing, or if a game is interrupted during continuous stroke, if the game is declared a called game, the outcome of that game is determined by the score at the point of the interruption.



Q 179

According to the rules, a team may not demand that a game be interrupted. However, can a team demand that the game be interrupted if a player suddenly becomes unwell and the referee doesn't realize it?

A

In an emergency, such as a player suddenly becoming unwell, which requires the game to be interrupted, dealing with the emergency should be the priority before demanding the game to be interrupted.

Explanation

1. The referee not only plays the role of "a judge", but has the discretion to decide on all aspects of the game, including counting time and dealing with emergency situations during the game.
2. In the event of an emergency, the referee should remain calm. If someone becomes unwell, the referee should first call a doctor, nurse or ambulance. In the meantime, the Chief Referee should announce "Time" and suspend the game.



Duties of the Chief Referee and Assistant Referee**Q**
180

After a successful pass through the first gate, the stroker's ball is stroked after it stops on the inner field but before the referee announces the gate pass. Is that stroke an ineffective play if the referee has not announced the successful pass?

A

The stroke does not represent ineffective play, but a proper play.

Explanation

1. It is not an ineffective play even if the referee doesn't announce the gate pass.
2. If the ball made a successful pass through the first gate, the referee shall immediately announce the pass so that the stroker's play is not delayed.

Q
181

The referee determines, in advance, the movement of the ball, regardless of whether the stroker confirms whether his/her ball is in contact with a touched ball. Can the referee convey his/her decision to the stroker without waiting for the stroker to confirm this with him/her?

A

The referee does not need to convey his/her decision to the stroker without waiting for the stroker's confirmation.

Explanation

This is something that the referee responds to when the stroker is confirming the position of the ball with the referee.

Q 182

Do the Recorder and Linesman also make a decision on an out-ball, make announcements, and address the ball?

A

The Recorder and Linesman also make a decision on an out-ball, make announcements, and address the ball, depending on the situation.

Explanation

This includes placing out-balls in the event of a referee asking a player to stop an out-ball.

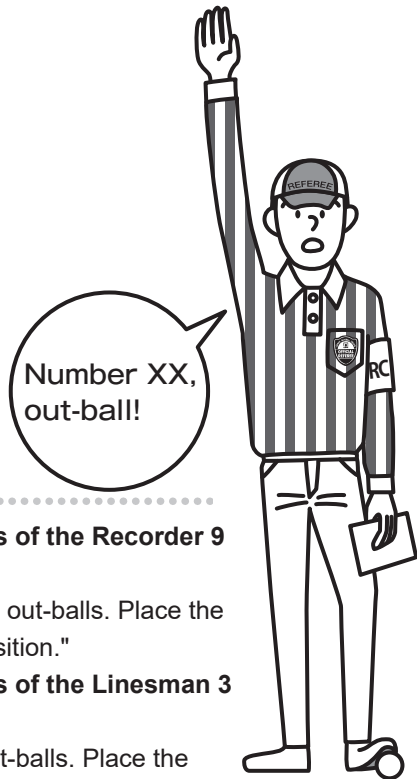

Reference

Article 23, Clause 6, Duties of the Recorder 9 of the Game Rules:

"Decide on and announce out-balls. Place the balls in an appropriate position."

Article 23, Clause 7, Duties of the Linesman 3 of the Game Rules:

"Decide and announce out-balls. Place the balls in an appropriate position."

Q 183

Where should the Linesman be positioned during the confirmation and inspection process before the start of the game? And, where should the Linesman be positioned when game set is announced?

A

1. The Linesman shall be positioned behind the Chief Referee, Assistant Referee and Recorder during the confirmation and inspection process before the start of the game.
2. When game set is announced, the Linesman shall be positioned where the players should make a line at the end of the game, and after game set has been announced, the Linesman shall assist the Chief Referee and Assistant Referee and get the manager and players to line up in their designated positions, and then position himself/herself behind the Chief Referee, the Assistant Referee, and the Recorder.

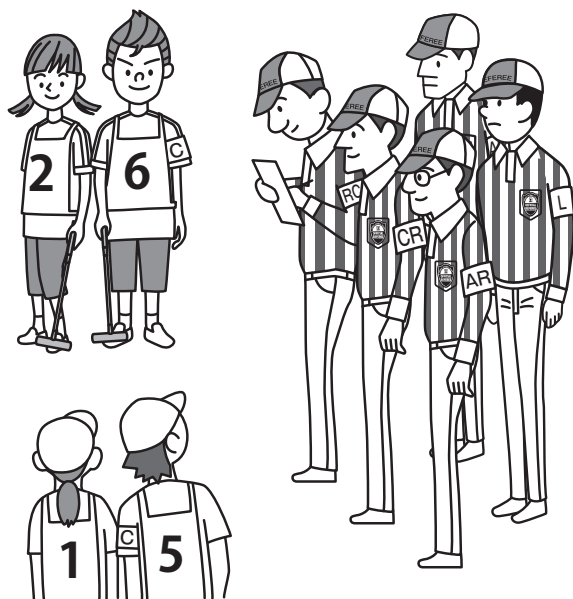

1 Refereeing Errors

Q
184

What should be done if the referee makes a mistake when calling a stroke, making a decision or an announcement, or when placing a ball?

A

The referee must immediately amend the decision.

Explanation

1. If the wrong stroking order is called, or the wrong decision, announcement or ball placement is carried out, and the stroker continues to play and next stroker plays, the game continues and the record remains valid.
2. The referee must ensure that the game is never hindered as a result of the wrong stroking order being called, or a wrong decision or announcement being made, or the wrong placement of a ball carried out.

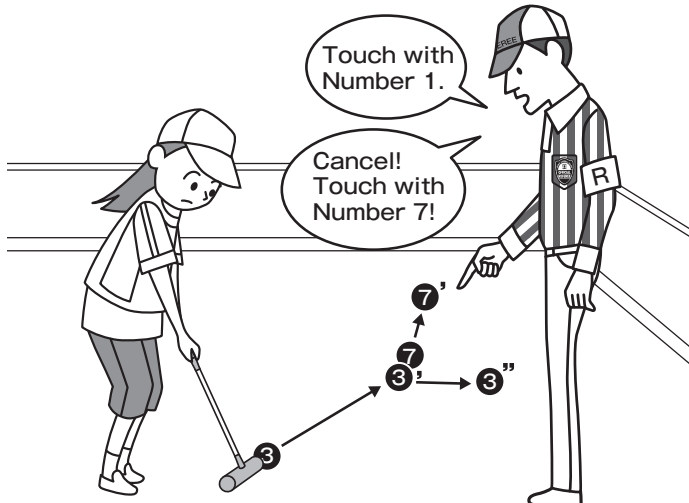

Q 185

A stroker's ball has successfully passed through the second gate. Just as the ball gets close to passing through the third gate, Referee B's foot happens to come into contact with the stroker's ball, and that ball enters the outer field. Does the stroker's ball become an out-ball? If it looks as though the stroker's ball will not make a successful pass through the third gate, and Referee B's foot happens to come into contact with the stroker's ball and then completely crosses over the gate line of the third gate to stop on the inner field, does this represent a successful pass through the third gate?

A

1. The stroker's ball that doesn't cross over the gate line of the third gate and enters the outer field becomes an out-ball.
2. If the stroker's ball completely crosses over the gate line of the third gate to stop on the inner field, this represents a successful pass through the third gate, and the stroker gains the right for a continuous stroke.

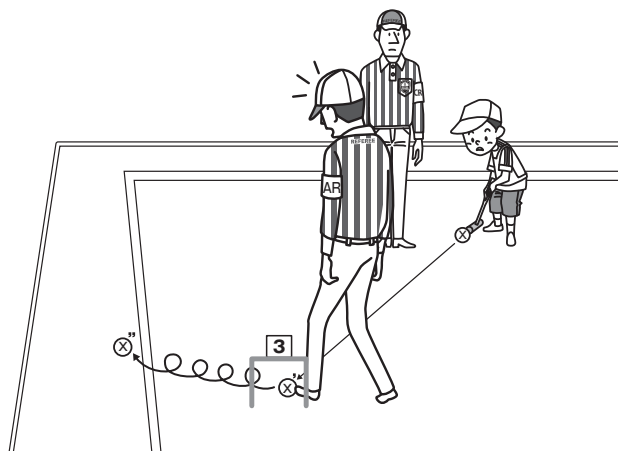

Explanation

1. If a referee comes into contact with a moving ball, then it is left as is and is valid until the ball stops.
2. If the referee comes into contact with a stationary ball, causing it to move, then it is immediately returned to the position it was in before it moved.
3. As is evident from these examples, the referee must avoid, at all costs, hindering the game by coming into contact with a ball.

Q
186

A referee who is positioned in the stroking direction mistakenly stops a ball on the inner field that looks as though it will be entering the outer field. Is this an in-ball?

A

This is not an in-ball, but an out-ball.

Explanation

If the referee stops the ball because he/she decides it is going to be an out-ball, it would be an out-ball, even if that ball was stopped on the inner field.

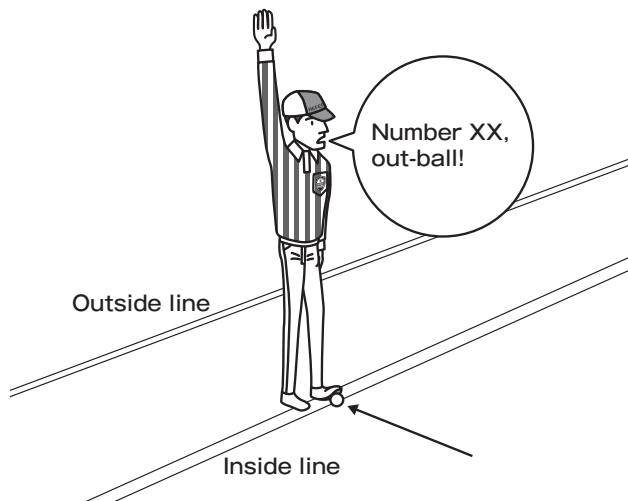

Q
187

At the end of the game, the Chief Referee confirms the score and decides on the winner. The captains of both teams then sign the record sheet. Afterwards, however, they realize that the scores on the record sheet have been recorded the wrong way around: the scores of the leading team are recorded as that of the following team and the scores of the following team are recorded as that of the leading team. How is the result amended?

A

The Chief Referee gathers the group of referees in charge of that game and the captains of both teams, and after confirming that the correct winner had been declared, shall then amend the scores on the record sheet in front of everyone.

Explanation

In order to avoid this type of situation, the following should be ensured:

- a. That the Recorder correctly enters the necessary items into the record sheet.
- b. That the Chief Referee confirms the contents of the record sheet.
- c. That the captain, after confirming the contents, signs the record sheet.

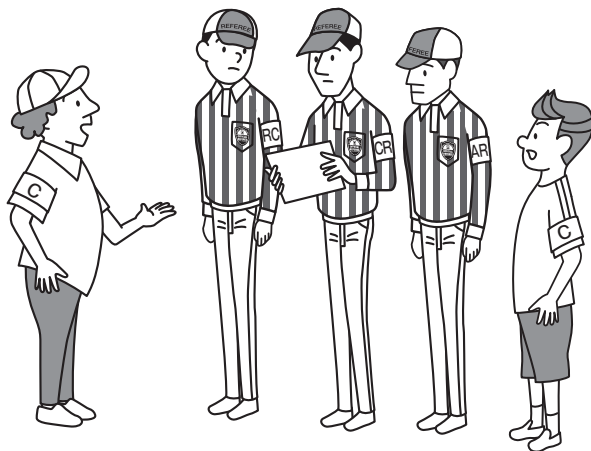

Q
188

Despite the fact that a manager indicates a player substitution to the Recorder, the Recorder forgets to advise the Chief Referee, and the substitute stroker then strokes or carries out a foul without the approval or announcement of the substitution by the Chief Referee. Can the game continue?

A The game continues.

Explanation

According to [III] 17 (1) Refereeing Errors 1) (ii) c, "If the recorder has been notified of a substitution but fails to advise the chief referee, and the player is substituted without approval or being announced, and he/she strokes, or his/her move results in a foul, the game is continued as is."

- (1) If the fact that a substitute stroker has played without approval or announcement of the substitution becomes apparent while the substitute stroker is playing, at that point the Recorder advises the Chief Referee, and the Chief Referee approves and announces the substitution.
- (2) If the fact that a stroker has gone on to play without approval or announcement of the substitution becomes apparent after the call for the stroker playing after the substitute stroker is called, the Recorder advises the Chief Referee when the call for the next stroker to play after the substitution is called, and the Chief Referee approves and announces the substitution.

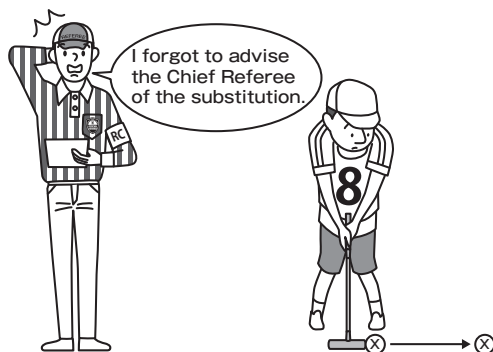

Others

2 Others

Q
189

Can a stroker pick up and remove a small stone that is lying on the ground in the direction in which that stroker is about to stroke?



A

The stroker may pick up and remove that stone.

Explanation

The ball must be stroked within 10 seconds.

Q
190

A strong wind is blowing during the game and causes a stationary ball to move. Can the game continue?

A

The game can continue once the referee returns all the balls that have moved to their original positions.

Explanation

If natural phenomena causes a ball/balls to move, this is an invalid move, and the referee returns all the balls that have moved as a result to their original positions.

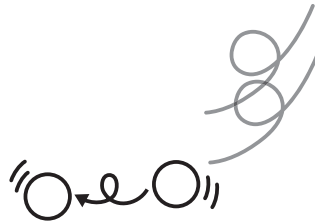

Reference

Article 11, Clause 2, Invalid Moves 1 (10) (v) of the Game Rules:

"When a stationary ball moves as the result of weather conditions, or as the result of the way the gate, the goal-pole, the inside line, or the lines forming the start area have been set."

Q 191

If a stroker causes a gate or goal-pole to fall over, and that gate, etc. comes into contact with the ball, or causes it to move, does this represent an invalid move?

A

As long as this wasn't caused intentionally, this would be deemed as an invalid move, and all the balls that moved are returned to the positions they were in before moving.

Explanation

1. Gates or goal-poles that fall over or collapse represent an equipment setup issue.
2. If a gate or goal-pole falls over or becomes dislodged as the result of a deliberate act by a stroker, regardless of whether the gate or goal-pole comes into contact with the ball or not, the Chief Referee or Assistant Referee shall determine that this represents play interference.



Reference

Article 11, Clause 2, Invalid Moves 1 (10) (v) of the Game Rules:

(Refer to the same rule outlined in Q190.)

Q
192

During a Spark, the stroker's ball sinks into the court because the court is soggy due to rain. Can the stroker pick up his/her ball and smooth over the court surface in order to continue playing?

A

The stroker may not pick up his/her ball and smooth over the court surface, but should continue to stroke.

Explanation

1. The stroker is not permitted to touch his/her ball in order to smooth over the surface of the court. It is a ball touch foul at the point that the stroker handles his/her ball.
2. Any items agreed for each match should always be followed.



Q
193

When stroking or sparking, can the stroker even out any uneven surface that lies in the stroking direction?

A

The stroker can use the hand or foot to even out any uneven surface.

Explanation

1. If the stick is used to even out the uneven surface, the referee will caution that player, and if the player doesn't comply, the Chief Referee or Assistant Referee may decide that this constitutes play interference. Always use the hand or foot to even out any uneven surface.
2. The stroker's ball shall be stroked or sparked within 10 seconds.



Q
194

When stroking or sparking, can the stroker draw a line or mark on the field or free zone?

A

The stroker may not draw a line or mark on the field or free zone.

Explanation

If a stroker draws a line or marks on the field or free zone, the referee will caution that player, and if the player doesn't comply, the Chief Referee or Assistant Referee may decide that this constitutes play interference.

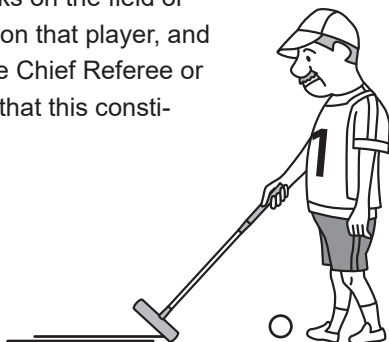

Q
195

Other than during practice, do players have to wear uniforms at all official games and matches organized by the city or ward? Or, is this something that is determined by agreement at individual tournaments, even though the tournament may be official? And, to what degree do the uniforms of the mixed teams have to match?

A

1. The degree of matching uniforms is decided by the organizer of each tournament.
2. As a rule, even teams with players of all ages and both genders must wear the same uniform.

Explanation

Although it is preferable that all players adhere to the practice of wearing uniforms when competing, this is determined by the organizer, and will depend on the nature of the tournament.

Q
196

Some players only wear the number indicating their playing order on the front of the shirt. Shouldn't they wear the number on the back of the shirt as well?

A

When participating in a match, players should be advised to wear the playing order number in accordance with the implementation conditions of that match.

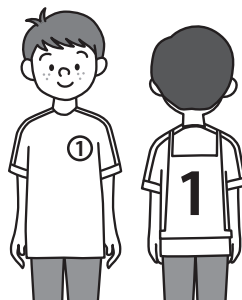

Reference

Article 4, Clause 3, Clothing 1 (3) (i) of the Game Rules:

"On the chest and on the back."

Article 4, Clause 3, Clothing 1 (3) (ii) of the Game Rules:

"On the chest"

Q
197

The referee kit includes a marker and a scale, but does the referee always have to have these on hand? And, how are the marker and scale used?

A

1. Markers and scales are aids, and therefore do not always have to be on hand. It is, however, preferable to ensure the accuracy of the referee's decision.
2. The marker is used as follows: When a stroker requests that a ball be temporarily moved, the referee picks up the ball to be temporarily moved and places the marker in the position where that ball was in. The referee then picks up the marker after the stroke or a Spark by the stroker, and returns the temporarily moved ball to the position that was marked.
3. The scale is used as follows: When a stroker requests that a ball that is at the back side of the first gate and will obstruct a pass through the first gate be temporarily moved, and it is unclear whether that ball lies within the width of one ball from the gate line of the first gate, the scale can be used to decide whether the distance between the outer edge of that ball and the gate line of the first gate is 7.5 cm (the width of a ball) or less. Alternatively, if it is unclear whether the distance between the outer edge of the sparked other ball and the outer edge of the stroker's ball is 10 cm or more, the scale can be used to decide whether a Spark is successful. The scale can also be used when it is unclear whether a ball entered the outer field, or whether a ball completely crossed over a gate line, by positioning the scale vertically against the outer edge of the inner field or the gate line.
4. Please be aware that the scale to be carried by the referee should be exactly 7.5cm x 10cm in size.

Scale (ex.)

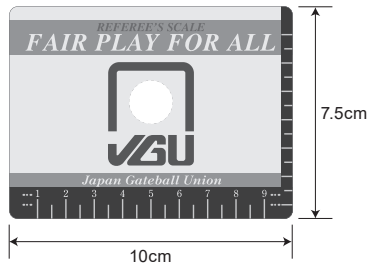

Marker (ex.)



Q
198

If a marker placed on the field causes the direction that the ball is moving in to change, what should the referee do?

A

The referee should consider the marker as a stone, and that ball that has changed direction as a result of the marker remains in the position it stops in after moving.

Q
199

When setting up the outside line 80 cm outside the inside line, is the outside line set up 1 m outside the inside line only where the start area lies?

A

The distance between the outside line and inside line should be kept the same. The outside line is drawn 80 cm outside the inside line even where the start area lies.

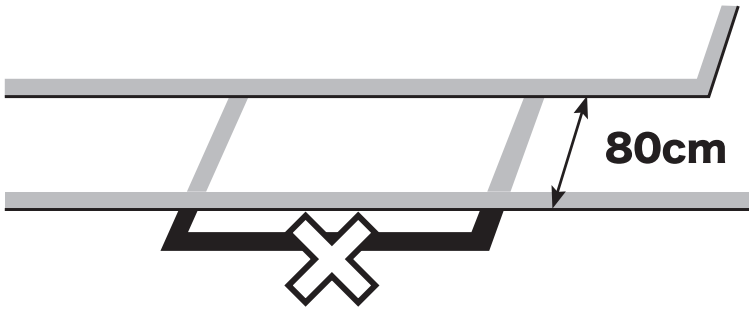

Reference

Article 1, Clause 1, Court 2 (1) (ii) of the Game Rules:

"The outer field is a fixed area 1 m in width, in principle, that lies outside the inner field. Its outer edge shall be bounded by the outside line and its inner edge shall be bounded by the inside line. The width of the outer field shall be set between 50 cm and 1 m."

Article 1, Clause 1, Court 3 (1) of the Game Rules:

"The start area is a rectangle created by four points - two points that are 1 m and 3 m from the first corner on the fourth line, and two points where two vertical lines drawn outward from the first two points intersect the outer edge of the outer field."

Q 200

The distance from the start area to the first gate is sometimes set at less than 4 m for beginner's matches. What sort of situation does this apply to?

A

The following situations may apply:

- (1) At a beginner's match, the distance to the first gate, which is generally regarded as a challenge for beginners, is reduced to 3 m or 2 m to make it easier for beginners to participate in the game.

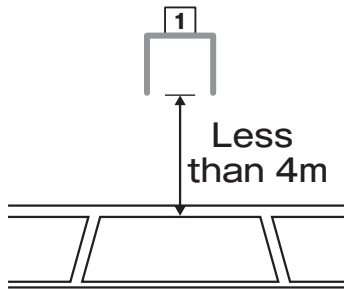

- (2) When the line is changed as the result of the decision by the organizer of the match or tournament for reasons such as heavy rainfall that creates difficult conditions on the field, making it challenging to achieve a successful pass through the first gate.

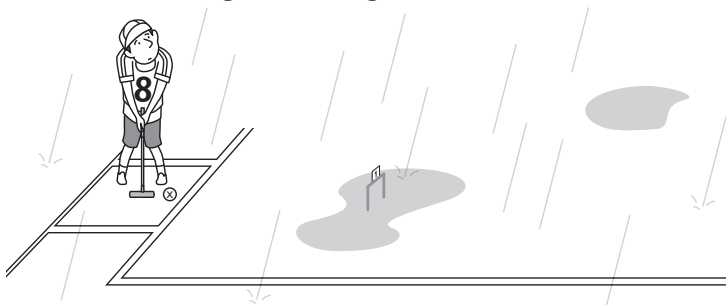

Explanation

These are special conditions that are determined by the implementation conditions introduced for each match or tournament. The distance is normally set at 4 m.

Reference

Article 1, Clause 1, Court 4 (3) (i) of the Game Rules:

"The point exactly between both legs of the first gate is positioned at a point 2 m from the inside line and at a right angle to the third line from a point 4 m from the first corner, in the direction of the second corner. The gate shall be set so that the (imaginary) gate line, which passes through this center point and runs parallel to the fourth line, is in contact with the outermost edge of both legs of the gate facing the second line."

Q
201

Does the line on the outside of the court (the outside line) have to be set?

A

The outside line should be set.

Explanation

There are times when the outside line isn't drawn on the court when the court is being used for practice, but it is important to make it a habit to draw the outside line and allow no one, other than the stroker and referees, to enter the court (within the outside line).

Reference

Article 1, Clause 1 Court 2 (1) (ii) a. of the Game Rules:

"The outside line should be wide enough to be clearly visible, while the color of the line should be easily identifiable on the court surface. The outside line shall be set inside the outer field along the outer edge of the outer field."

Q
202

If, as the result of an emergency, the captain is not able to carry out his/her duties, the manager can then designate another player to be the substitute captain, indicating this to the referee. However, if that captain is not able to return to duties at the next match, can the captain be changed?

A

The captain should be decided from amongst the other players before the next game begins, and the captain's name entered into the order sheet and submitted to the referee.

Explanation

1. There is no need to decide on the captain at the time of registering the participants of a match or tournament. The captain is decided on when the order sheet for that game is submitted. In other words, the captain can change with each game.
2. If a team announces their intentions to abandon the game, or if a player who was the captain is missing and as a result there are less than 5 players at the start of the next game, this will result in the game being forfeited, and the other team winning.

Reference

Article 8, Clause 1, Abandonment 1 (2) of the Game Rules:
"A team has less than five players at the start of the game."

Q 203

The following rule applies to time over, stroking and ball touch fouls: "If a foul occurs during the stroker's actions on sparking, the process outlined in Article 16, Clause 4, Sparking Foul 2 on sparking foul shall be followed depending on the situation." What kind of situations does this apply to?

A

It refers to any of the following fouls resulting from the actions on sparking:

- a. Time over
- b. Stroking foul
- c. Ball touch foul

(1) Time Over

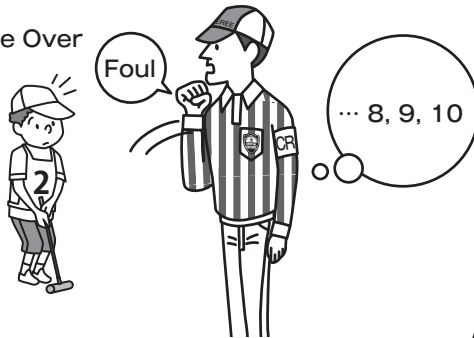

(2) Stroking Foul



(3) Ball Touch Foul

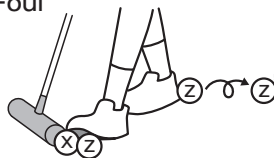

Explanation

1. As the position of the balls would differ depending on the conditions under which the foul occurs, the Game Rules do not specify each of these individually.
2. For example, if time over is generated during the stroker's actions on sparking, the ball would be dealt with differently depending on the stage of sparking. As a result, Article 16, Clause 4, 'Sparking Foul 2' would be referred to in order to determine the position of the balls. The stroker's ball becomes an out-ball from where it stopped following the Touch, while the other ball is placed where it stopped following the Touch or where it was when set.

Reference

Article 9, Clause 2, Time Over 2 (iii) of the Game Rules:

"If a time-over foul takes place during a stroker's action on sparking, Article 16, Clause 4, 'Sparking Foul 2' shall apply, depending on the situation at the time."

Article 12, Clause 4, Stroking Foul 2 (5) of the Game Rules:

"If a stroking foul takes place during a stroker's action on sparking, Article 16, Clause 4, 'Sparking Foul 2' shall apply, depending on the situation at the time."

Article 18, Clause 1, Ball Touch Foul 2 (4) of the Game Rules:

"If a ball touch foul occurs during the stroker's actions on sparking, the process outlined in Article 16, Clause 4, 'Sparking Foul 2' on sparking foul shall be followed, depending on the situation at the time."

Abbreviations

X=Stroker's ball

Z=Ball other than the Stroker's ball

CR=Chief Referee

AR=Assistant Referee

RC=Recorder

L=Linesman

C=Captain

M=Manager

Q & A Guide

The rules made clear!
All your questions answered!

Explaining the 2019 Game Rules

Published on March 20, 2020

Published by World Gateball Union

URL: <http://www.gateball.or.jp/jguweb/wgu/>

Printed and bound by Yukou Co.,Ltd.

Illustrations: Manatee Ogata

All rights reserved. No part of this publication may be reproduced or transmitted without permission from the World Gateball Union.